

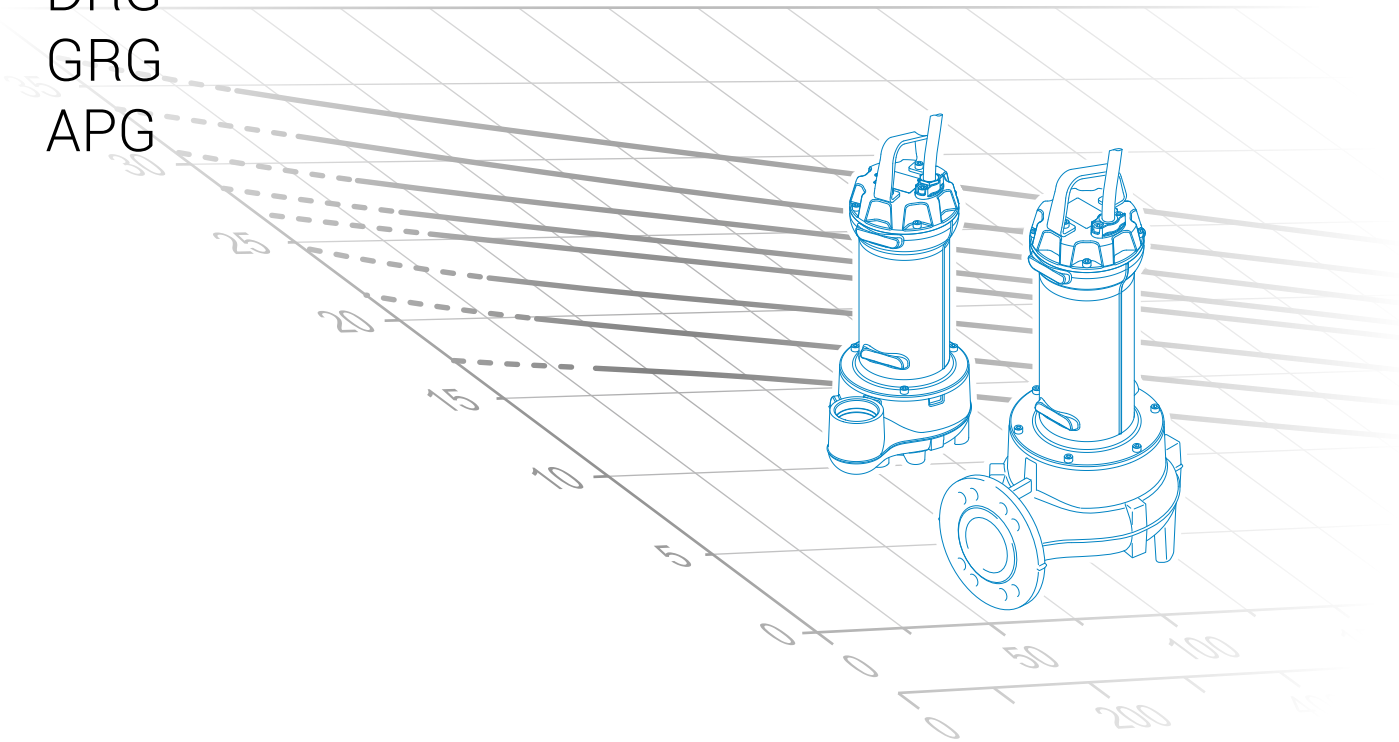

water solutions

Grey SERIES

- DGG
- DRG
- GRG
- APG



D A T A B O O K L E T



water solutions

Grey SERIES

DGG

DRG

GRG

APG



D A T A B O O K L E T

Grey Series

General characteristics

Motor

- Electrical submersible pumps in GJL-250 cast iron
- Two silicon carbide (2SiC) mechanical seals in oil sump
- Ecological dry motor with thermal protection
- Sensor for detecting water in the mechanical seal oil sump
- Self lubricated ball bearings



Hydraulic families



DG (Draga)

page 7

- Set-back vortex impeller
- Used with unstrained soiled biological wastewaters and sewage and for civil lifting applications. It is thus ideal for wastewater treatment plants, sewer systems, livestock farms, industry and agriculture.



DR (Dreno)

page 19

- Multi-channel open impeller
- Designed for mainly professional and industrial use such as wastewater treatment plants, sewage systems and livestock farms, it is particularly suitable for the treatment of liquids containing suspended solids or filaments, and low or medium density activated sludges.



GR (Grinder)

page 45

- Impeller with grinder system
- Designed for professional and industrial use, it is suitable for the treatment of liquids containing suspended solids or fibres, and low or medium density activated sludges.



AP (Alta Prevalenza)

page 49

- High head impeller
- Suitable for clear wastewater, rainwater and seepage. The considerable manometric head guarantees excellent results for the creation of water features and decorative fountains; suitable for use in agriculture, irrigation and the fish processing sector.

Operating ranges

DGG

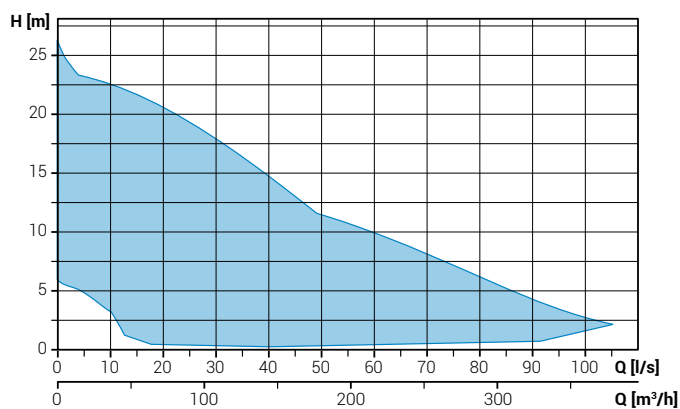

DRG

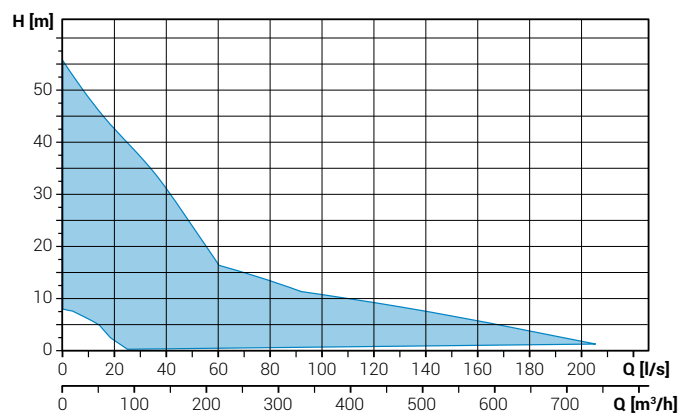

GRG

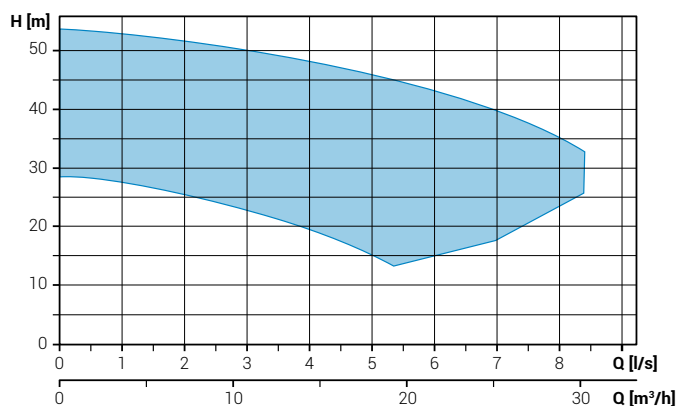

APG

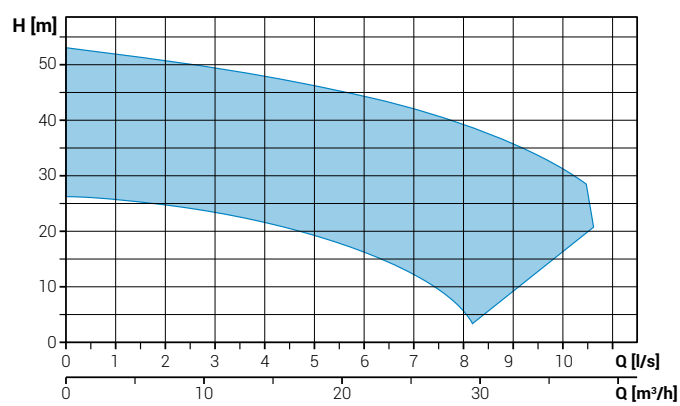

Versions available

- Electrical variants

NAE	No electric accessories
TS	Thermal protection, sensor for detecting water in the mechanical seal oil sump

- Cooling system

N	No cooling and/or seal flushing system
----------	--

- Set of mechanical seals

2SiC	2 mechanical seals in silicon carbide
-------------	---------------------------------------

Key to product code

DGG 300/2/G65V C0ET5

①
②
③
④
⑤
⑥
⑦
⑧
⑨

- | | |
|---|---|
| <p>① Family</p> <p>② Series</p> <p>③ Power (HPx100) / motor poles</p> <p>④ Delivery rate</p> <p style="margin-left: 20px;">(A) TYPE (GAS thread/Flanged)</p> <p style="margin-left: 20px;">(B) DIAMETER (mm)</p> <p style="margin-left: 20px;">(C) POSITION</p> <p style="margin-left: 40px;">V = vertical</p> <p style="margin-left: 40px;">H = horizontal</p> | <p>⑤ Hydraulic model</p> <p>⑥ Version number</p> <p>⑦ Motor size</p> <p>⑧ Motor phases</p> <p style="margin-left: 20px;">M = Single-phase</p> <p style="margin-left: 20px;">T = Three-phase</p> <p>⑨ Power supply voltage frequency</p> <p style="margin-left: 20px;">5 = 50Hz</p> <p style="margin-left: 20px;">6 = 60Hz</p> |
|---|---|

Installations

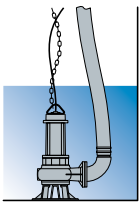

Free installation

The electric pump, standing on its feet or base, is connected to the delivery flexible pipe using a joint fixed to the discharge. This installation allows to move easily the electrical pump.

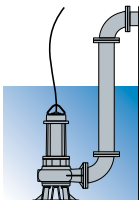

Fixed installation

The electric pump, standing on its feet or base, is connected to the delivery pipe, which is screwed to the discharge if threaded, or fixed to a bend if the port is flanged. The pump-hose connection may be threaded or flanged, depending on the pump fitting.

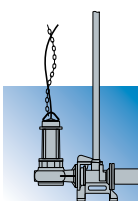
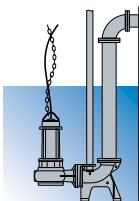

Installation with base coupling foot

Available for electric pumps with threaded discharge. The pump unit is supported by a special device fitted to the delivery pipe. This device can be installed at any time without having to empty the tank. It simplifies any maintenance work on the pump, which can be lifted out and resubmerged with great ease. It is recommended in particular for installations of small size, and does not require the pump to be resting on the bottom of the tank.

Pumps with vortex impeller

Operating ranges

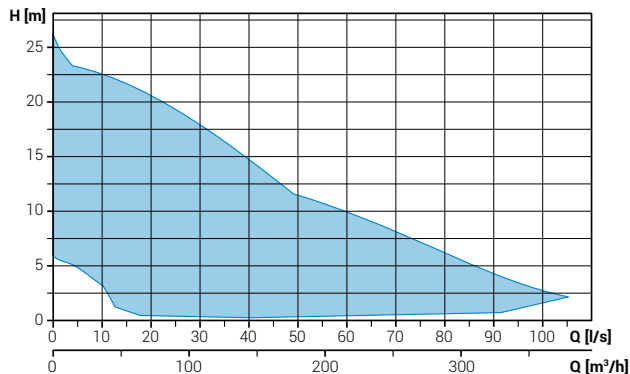

Range characteristics

Motor power	1.8 ÷ 15.0 kW
Poles	2 / 4
Insulation class	H
Degree of protection	IP68
Discharge	GAS 2½" vertical DN65 ÷ DN150 horizontal
Free passage	max 125 mm
Max flow rate	106 l/s
Max head	26.1 m

Motor

Ecological dry motor with thermal protections

Cable

S1RN8-F electric cable. Standard version 10 m cable length

Mechanical seals

Two silicon carbide (SiC) mechanical seals in oil sump.

Applications

Used with unstrained soiled biological wastewaters and sewage and for civil lifting applications. It is thus ideal for wastewater treatment plants, sewer systems, livestock farms, industry and agriculture

Installations

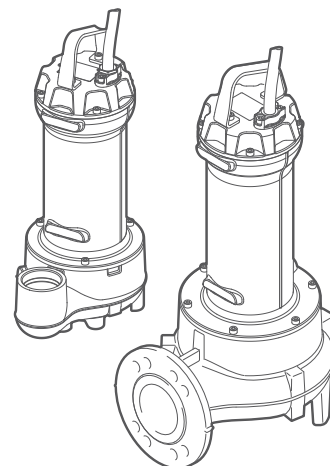
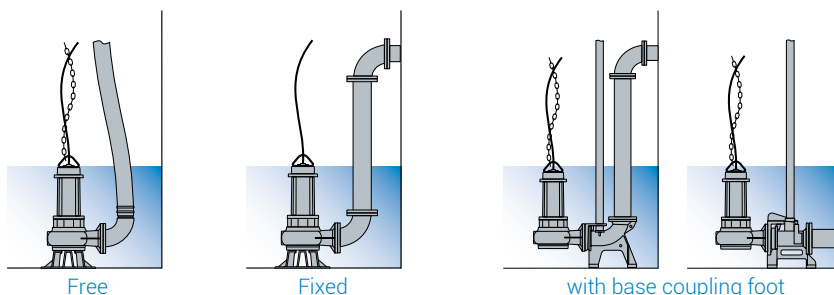

Versions

Electrical variants	NAE, TS
Cooling system	N
Mechanical seals	2SiC

Operating specifications

Max operating temperature	40 °C
PH of treated fluid	6 ÷ 14
Viscosity of treated fluid	1 mm²/s
Maximum immersion depth	20 m
Density of treated fluid	1 Kg/dm³
Acoustic pressure max	<70dB
Max starts per hour	30

Construction materials

Case	Cast iron EN-GJL 250
Hydraulic parts	Cast iron EN-GJL 250
Impeller	Cast iron EN-GJL 250
Nuts and bolts	Stainless steel - Class A2-70
Standard gasket	Rubber - NBR
Shaft	Stainless steel - AISI 431
Paint type	Ecological bicomponent epoxy (~ 200 µm)

DGG 250-300/2/G65V

Performances

	l/s	0	2	4	6	8	10	12	14
	l/min	0	120	240	360	480	600	720	840
	m ³ /h	0	7.2	14.4	21.6	28.8	36.0	43.2	50.4
①	DGG 250/2/G65V B0AT5	13.0	11.2	8.7	6.5	4.8	3.4	2.0	
②	DGG 300/2/G65V A0ET5	15.0	13.1	10.9	8.7	6.7	4.9	3.4	1.9

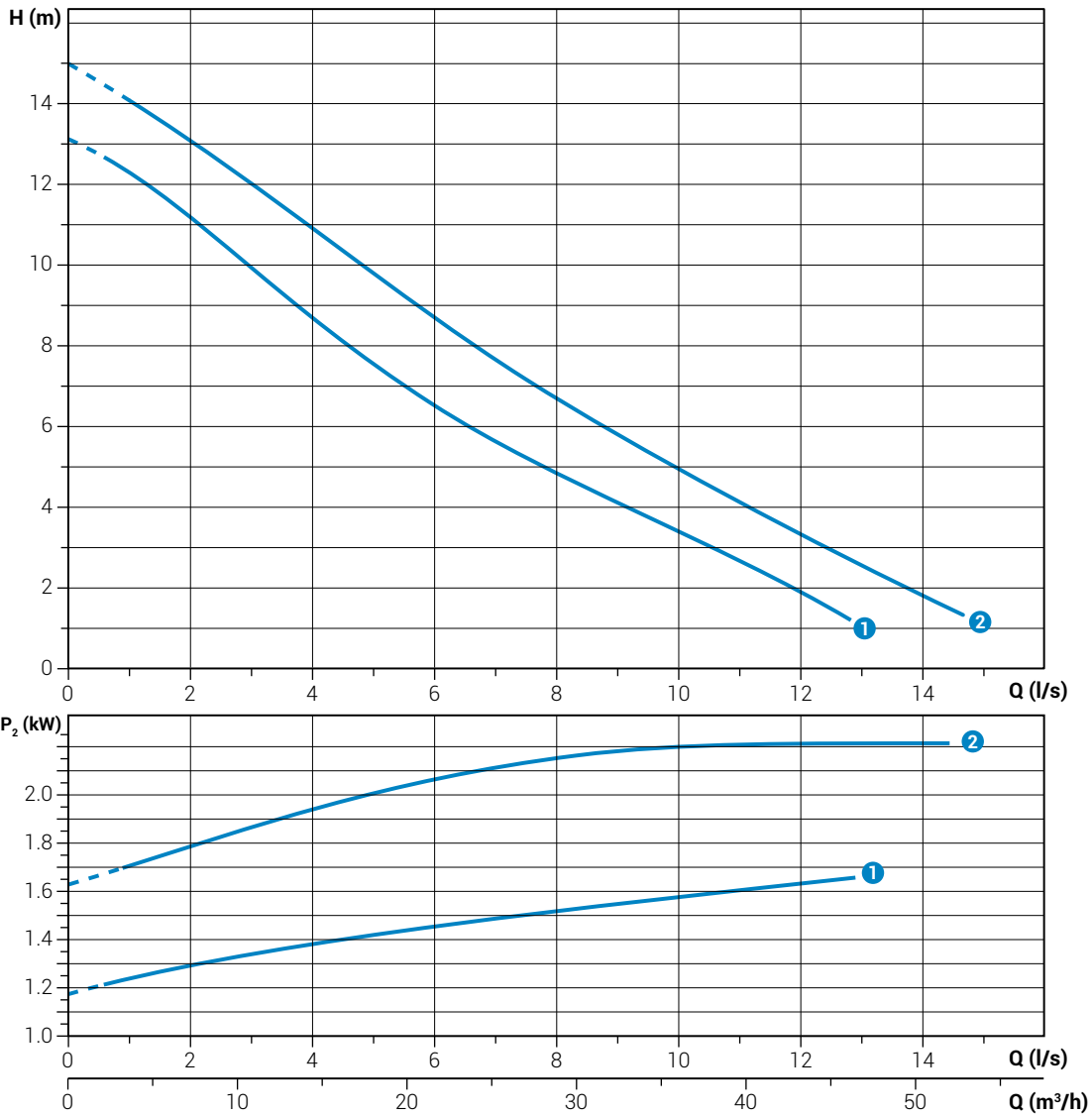

Characteristic curves according to UNI EN ISO 9906

Technical data

	V	Phases	P1 (kW)	P2 (kW)	A	Rpm	Start	Cable	Ø	Free passage	
①	DGG 250/2/G65V B0AT5	400	3	2.19	1.8	3.7	2900	Dir	4G1	65 mm	
②	DGG 300/2/G65V A0ET5	400	3	2.76	2.2	4.62	2900	Dir	4G1.5+3x1	G 2½"	65 mm

DGG 250÷1000/2/65

Performances

	l/s	0	2	4	6	8	10	12	14	16	18	20	22	24	26
	l/min	0	120	240	360	480	600	720	840	960	1080	1200	1320	1440	1560
	m ³ /h	0	7.2	14.4	21.6	28.8	36.0	43.2	50.4	57.6	64.8	72.0	79.2	86.4	93.6
1	DGG 250/2/65 B0AT5	13.0	11.3	9.0	6.9	5.2	3.8	2.7	16						
2	DGG 300/2/65 C0ET5	15.1	13.4	11.0	9.1	7.4	5.6	3.9	2.6						
3	DGG 400/2/65 D0ET5	17.7	16.4	14.5	12.2	9.9	7.7	5.8	4.2	2.9					
4	DGG 550/2/65 A0FT5	19.5	18.4	17.0	15.4	13.6	11.7	9.8	7.9	6.1	4.4	2.9			
5	DGG 750/2/65 A0FT5	22.3	21.2	19.9	18.6	17.0	15.3	13.5	11.6	9.8	7.9	6.2	4.7		
6	DGG 1000/2/65 A0FT5	26.1	24.4	23.3	22.4	21.4	20.2	18.7	17.0	15.3	13.5	11.8	10.3	8.7	6.8

Characteristic curves according to UNI EN ISO 9906

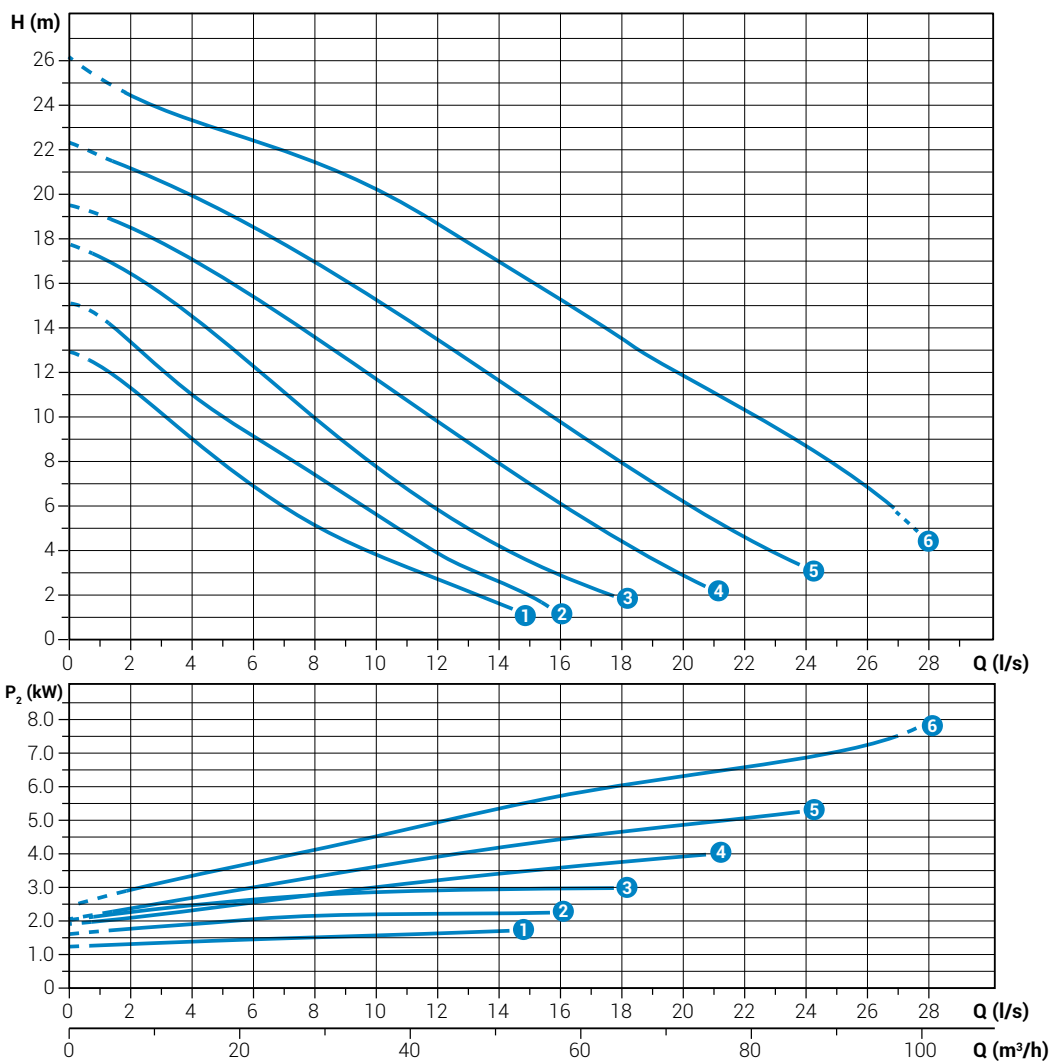

Technical data

	V	Phases	P1 (kw)	P2 (kw)	A	Rpm	Start	Cable	Ø	Free passage	
1	DGG 250/2/65 B0AT5	400	3	2.19	1.8	3.7	2900	Dir	4G1	DN65	65 mm
2	DGG 300/2/65 C0ET5	400	3	2.76	2.2	4.62	2900	Dir	4G1.5+3x1	DN65	65 mm
3	DGG 400/2/65 D0ET5	400	3	3.68	3.0	3.36	2900	Dir	4G1.5+3x1	DN65	65 mm
4	DGG 550/2/65 A0FT5	400	3	4.66	4.0	7.73	2900	Dir	4G1.5+3x1	DN65	65 mm
5	DGG 750/2/65 A0FT5	400	3	6.32	5.5	10.8	2900	Dir	4G1.5+3x1	DN65	65 mm
6	DGG 1000/2/65 A0FT5	400	3	8.51	7.5	13.7	2900	Dir	4G1.5+3x1	DN65	65 mm

DGG 250 ÷ 1000/2/80

Performances

	l/s	0	4	8	12	16	20	24	28	32	36
	l/min	0	240	480	720	960	1200	1440	1680	1920	2160
	m ³ /h	0	14.4	28.8	43.2	57.6	72.0	86.4	100.8	115.2	129.6
1	DGG 250/2/80 FOAT5	7.9	5.7	4.0	2.9	1.9					
2	DGG 300/2/80 GOET5	9.7	6.7	5.6	4.2	2.6					
3	DGG 400/2/80 HOET5	12.8	10.1	7.1	4.7	3.1	1.4				
4	DGG 550/2/80 NOFT5	17.5	15.0	12.4	8.9	5.9	3.9				
5	DGG 750/2/80 AOFT5	17.1	15.1	12.9	10.5	7.8	5.3	3.2	1.7		
6	DGG 1000/2/80 AOFT5	21.6	20.0	17.7	15.1	12.4	9.6	7.1	4.8	3.0	1.8

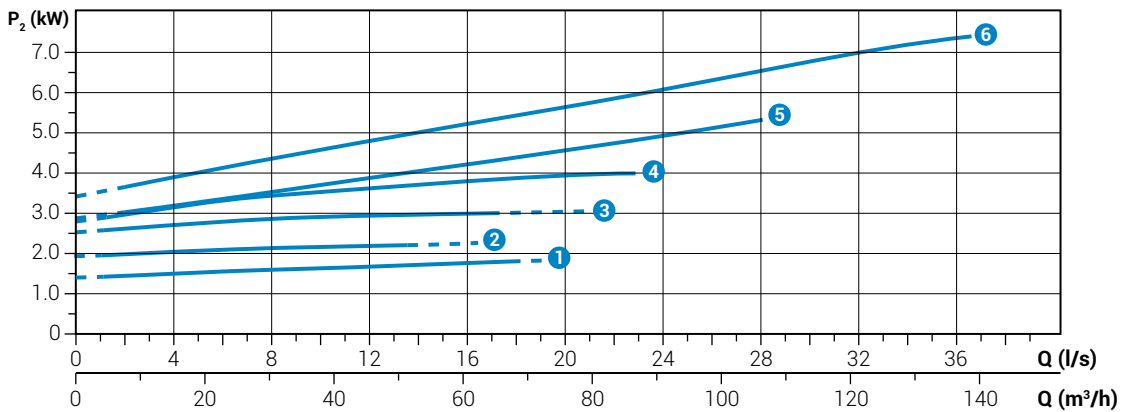
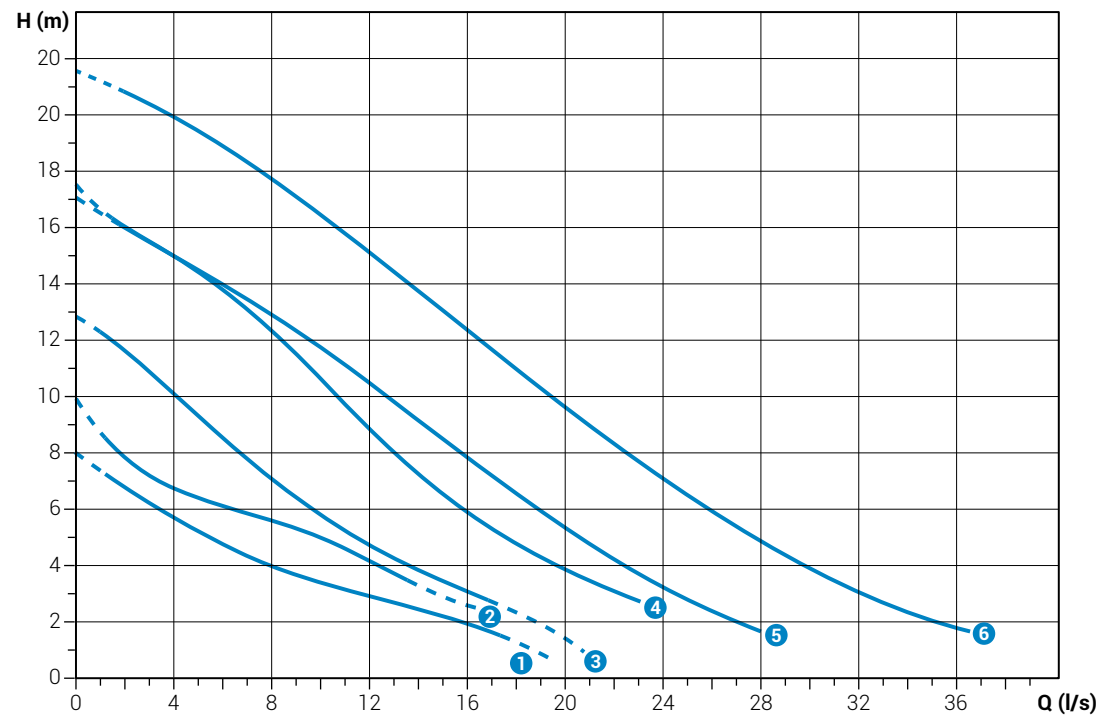

Technical data

	V	Phases	P1 (kW)	P2 (kW)	A	Rpm	Start	Cable	Ø	Free passage	
1	DGG 250/2/80 FOAT5	400	3	2.19	1.8	3.7	2900	Dir	4G1	DN80	80 mm
2	DGG 300/2/80 GOET5	400	3	2.76	2.2	4.62	2900	Dir	4G1.5+3x1	DN80	80 mm
3	DGG 400/2/80 HOET5	400	3	3.68	3.0	6.36	2900	Dir	4G1.5+3x1	DN80	80 mm
4	DGG 550/2/80 NOFT5	400	3	4.66	4.0	7.73	2900	Dir	4G1.5+3x1	DN80	80 mm
5	DGG 750/2/80 AOFT5	400	3	6.32	5.5	10.8	2900	Dir	4G1.5+3x1	DN80	80 mm
6	DGG 1000/2/80 AOFT5	400	3	8.51	7.5	13.7	2900	Dir	4G1.5+3x1	DN80	80 mm

Characteristic curves according to UNI EN ISO 9906

DGG 150 ÷ 400/4/65

Performances

	l/s	0	2	4	6	8	10	12	14	16	18	20	22
	l/min	0	120	240	360	480	600	720	840	960	1080	1200	1320
	m ³ /h	0	7.2	14.4	21.6	28.8	36.0	43.2	50.4	57.6	64.8	72.0	79.2
① DGG 150/4/65 H0AT5		7.5	7.2	6.6	5.8	4.6	3.4	2.4	1.6				
② DGG 200/4/65 F0ET5		10.4	9.8	9.2	8.4	7.4	6.3	5.0	3.6	2.0			
③ DGG 250/4/65 F0ET5		11.3	10.8	10.2	9.5	8.6	7.5	6.2	4.7	3.2			
④ DGG 300/4/65 F0ET5		12.2	11.6	11.0	10.4	9.6	8.7	7.6	6.3	4.8	3.2		
⑤ DGG 400/4/65 G0ET5		12.8	12.2	11.5	10.9	10.3	9.7	9.0	8.2	7.3	6.3	5.3	4.0

Characteristic curves according to UNI EN ISO 9906

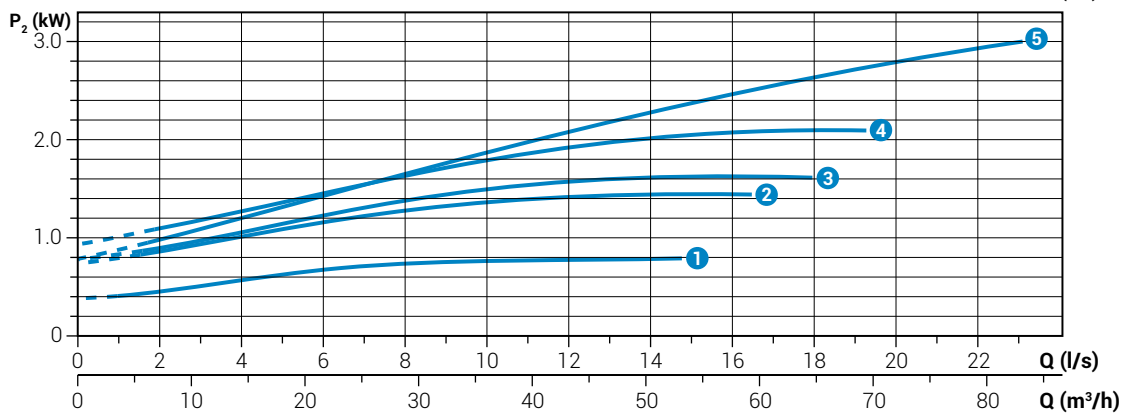
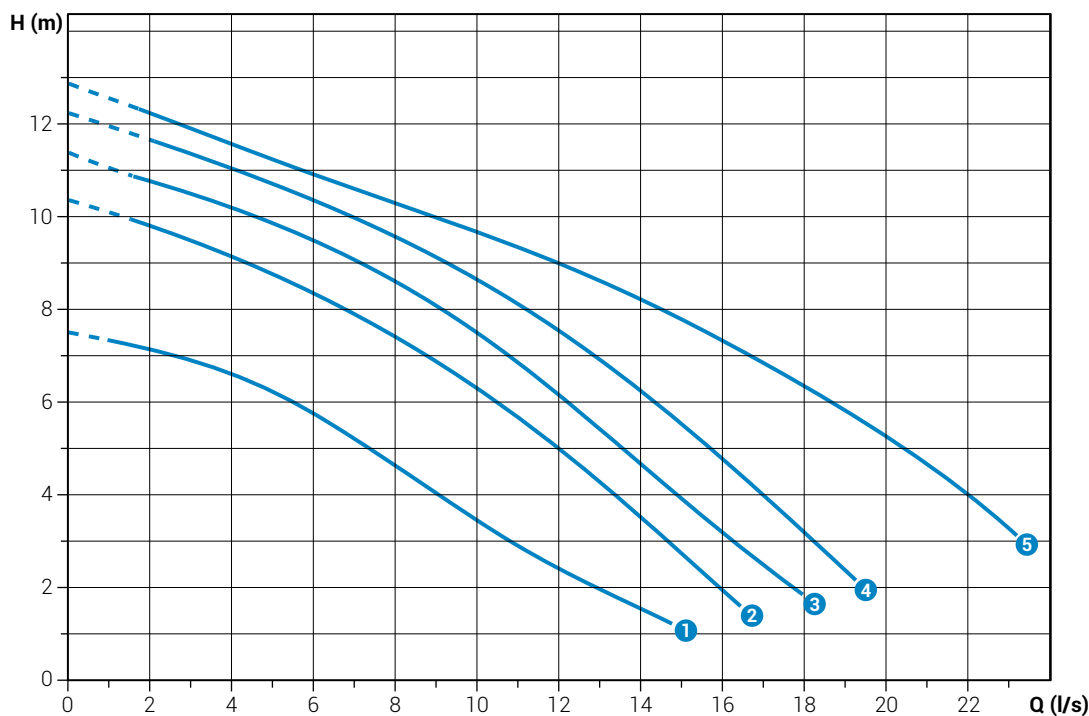

Technical data

	V	Phases	P1 (kw)	P2 (kw)	A	Rpm	Start	Cable	Ø	Free passage
① DGG 150/4/65 H0AT5	400	3	1.47	1.1	3.03	1450	Dir	4G1	DN65	45 mm
② DGG 200/4/65 F0ET5	400	3	1.84	1.5	3.4	1450	Dir	4G1.5+3x1	DN65	65 mm
③ DGG 250/4/65 F0ET5	400	3	2.22	1.8	4.3	1450	Dir	4G1.5+3x1	DN65	65 mm
④ DGG 300/4/65 F0ET5	400	3	2.7	2.2	5.15	1450	Dir	4G1.5+3x1	DN65	65 mm
⑤ DGG 400/4/65 G0ET5	400	3	3.68	3.0	6.72	1450	Dir	4G1.5+3x1	DN65	65 mm

DGG 150-200-250-300/4/80

Performances

	l/s	0	4	8	12	16	20	24
	l/min	0	240	480	720	960	1200	1440
	m ³ /h	0	14.4	28.8	43.2	57.6	72.0	86.4
1	DGG 150/4/80 LOAT5	5.9	5.1	3.9	2.7	1.3		
2	DGG 200/4/80 E0ET5	9.6	8.8	7.0	5.0	3.2	1.7	
3	DGG 250/4/80 E0ET5	10.4	9.7	8.1	6.1	4.2	2.6	1.3
4	DGG 300/4/80 E0ET5	11.3	10.4	9.0	7.4	5.6	3.8	

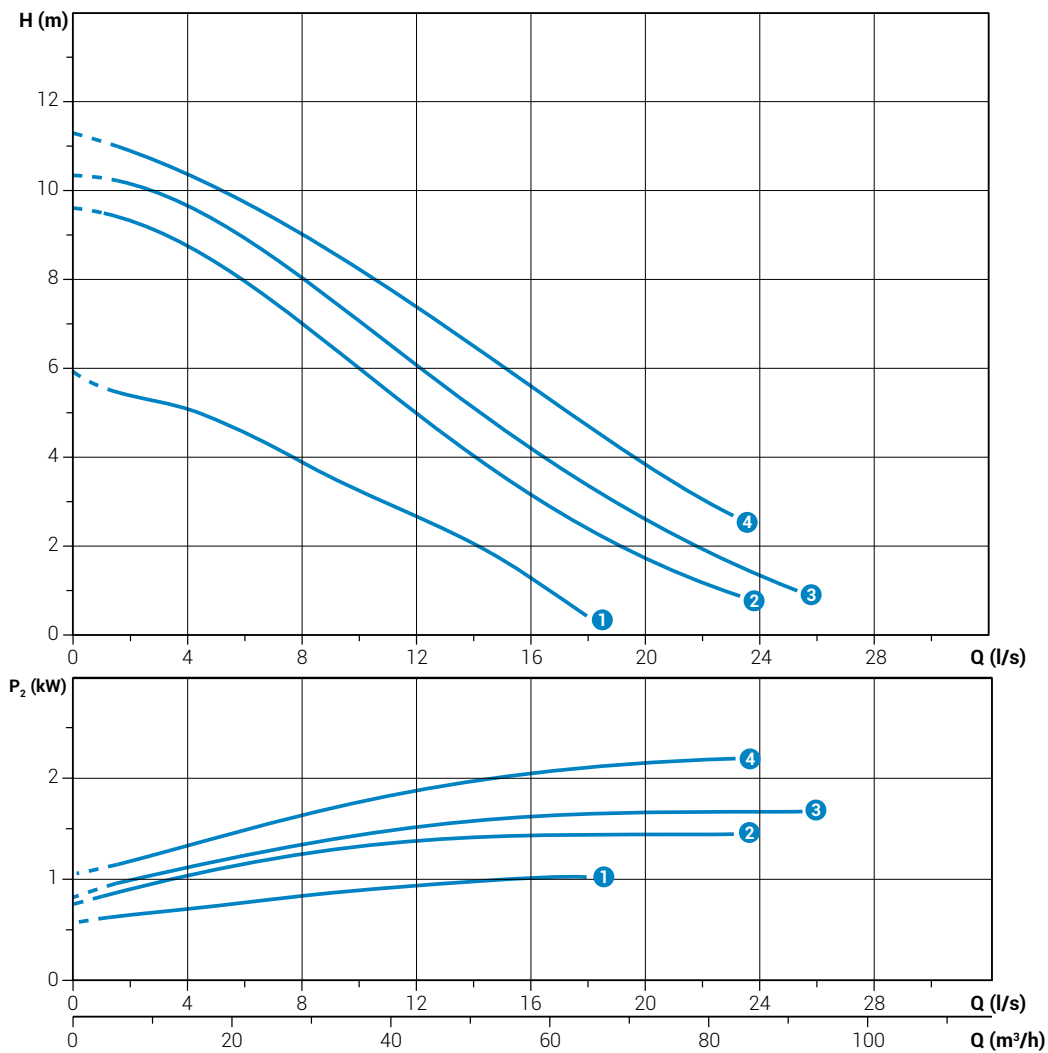

Characteristic curves according to UNI EN ISO 9906

Technical data

	V	Phases	P1 (kW)	P2 (kW)	A	Rpm	Start	Cable	Ø	Free passage	
1	DGG 150/4/80 LOAT5	400	3	1.47	1.1	3.03	1450	Dir	4G1	DN80	80 mm
2	DGG 200/4/80 E0ET5	400	3	1.84	1.5	3.4	1450	Dir	4G1.5+3x1	DN80	80 mm
3	DGG 250/4/80 E0ET5	400	3	2.22	1.8	4.3	1450	Dir	4G1.5+3x1	DN80	80 mm
4	DGG 300/4/80 E0ET5	400	3	2.7	2.2	5.15	1450	Dir	4G1.5+3x1	DN80	80 mm

DGG 400-550-750-1200/4/80

Performances

	l/s	0	4	8	12	16	20	24	28	32	36	40
	l/min	0	240	480	720	960	1200	1440	1680	1920	2160	2400
	m ³ /h	0	14.4	28.8	43.2	57.6	72.0	86.4	100.8	115.2	129.6	144
① DGG 400/4/80 M0ET5		11.4	10.3	9.2	8.1	6.9	5.5	3.8	1.9			
② DGG 550/4/80 D0FT5		14.4	13.5	12.7	11.6	10.2	8.6	6.7	4.7			
③ DGG 750/4/80 D0FT5		17.2	16.4	15.6	14.7	13.5	12.0	10.0	7.8	5.5	3.1	0.6
④ DGG 1200/4/80 D0HT5		22.8	22.0	21.4	20.8	20.0	18.9	17.3	15.4	13.0	10.4	7.7

Characteristic curves according to UNI EN ISO 9906

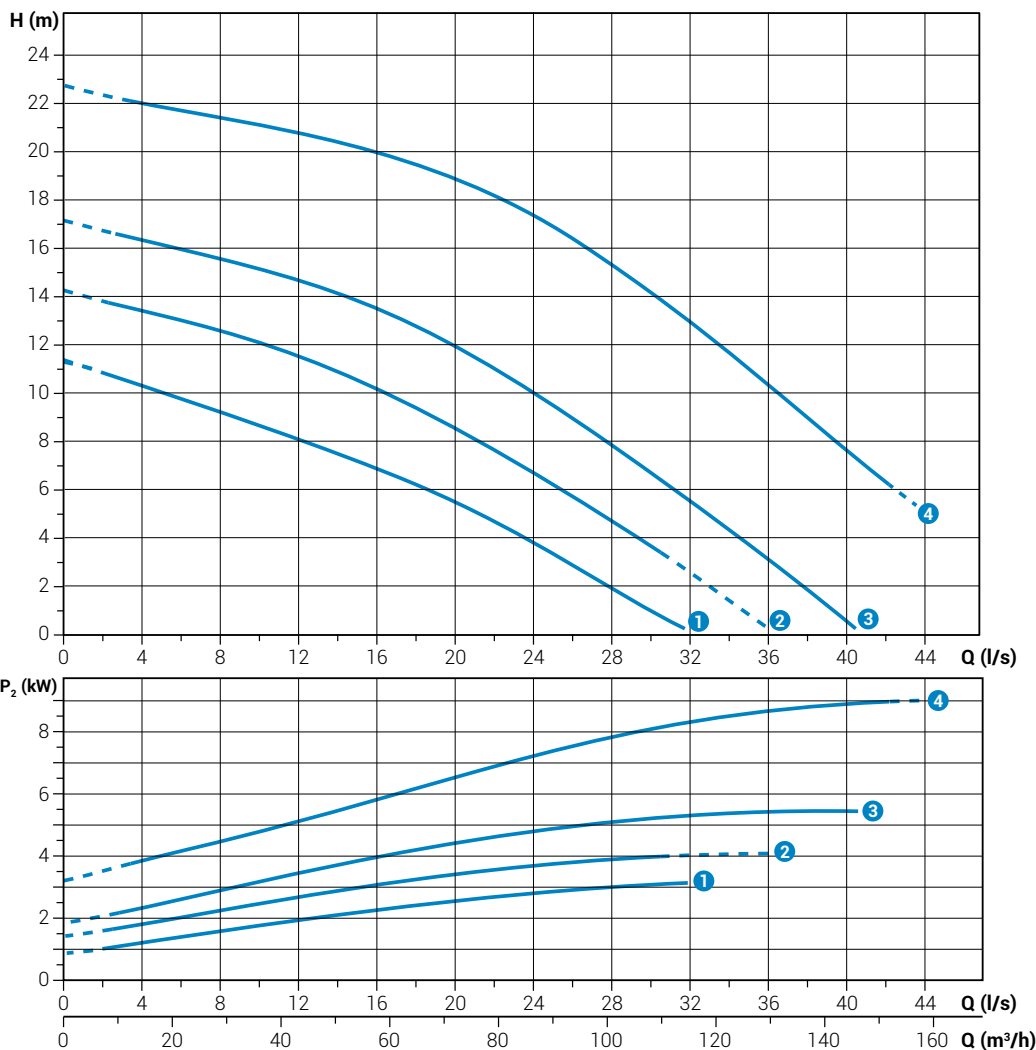

Technical data

	V	Phases	P1 (kw)	P2 (kw)	A	Rpm	Start	Cable	Ø	Free passage
① DGG 400/4/80 M0ET5	400	3	3.68	3.0	6.72	1450	Dir	4G1.5+3x1	DN80	80 mm
② DGG 550/4/80 D0FT5	400	3	4.62	4.0	8.4	1450	Dir	4G1.5+3x1	DN80	60 mm
③ DGG 750/4/80 D0FT5	400	3	6.38	5.5	11.8	1450	Dir	4G1.5+3x1	DN80	60 mm
④ DGG 1200/4/80 D0HT5	400	3	10.2	9.0	17.0	1450	Y Δ	7G1.5+3x1	DN80	60 mm

DGG 200 ÷ 550/4/100

Performances

	l/s	0	4	8	12	16	20	24	28	32	36	40	44
	l/min	0	240	480	720	960	1200	1440	1680	1920	2160	2400	2640
	m³/h	0	14.4	28.8	43.2	57.6	72	86.4	100.8	115.2	129.6	144	158.4
1	DGG 200/4/100 E0ET5	7.9	7.2	5.8	4.2	2.9	2.1						
2	DGG 250/4/100 E0ET5	8.7	8.0	6.4	4.8	3.5	2.6	1.8					
3	DGG 300/4/100 E0ET5	9.7	9.1	7.9	6.4	4.9	3.7	2.9					
4	DGG 400/4/100 D0ET5	10.6	9.8	8.6	7.0	5.6	4.5	3.8	3.1	2.2	1.3		
5	DGG 550/4/100 G0FT5	11.7	11.3	10.6	9.7	8.6	7.6	6.4	5.3	4.2	3.2	2.3	1.4

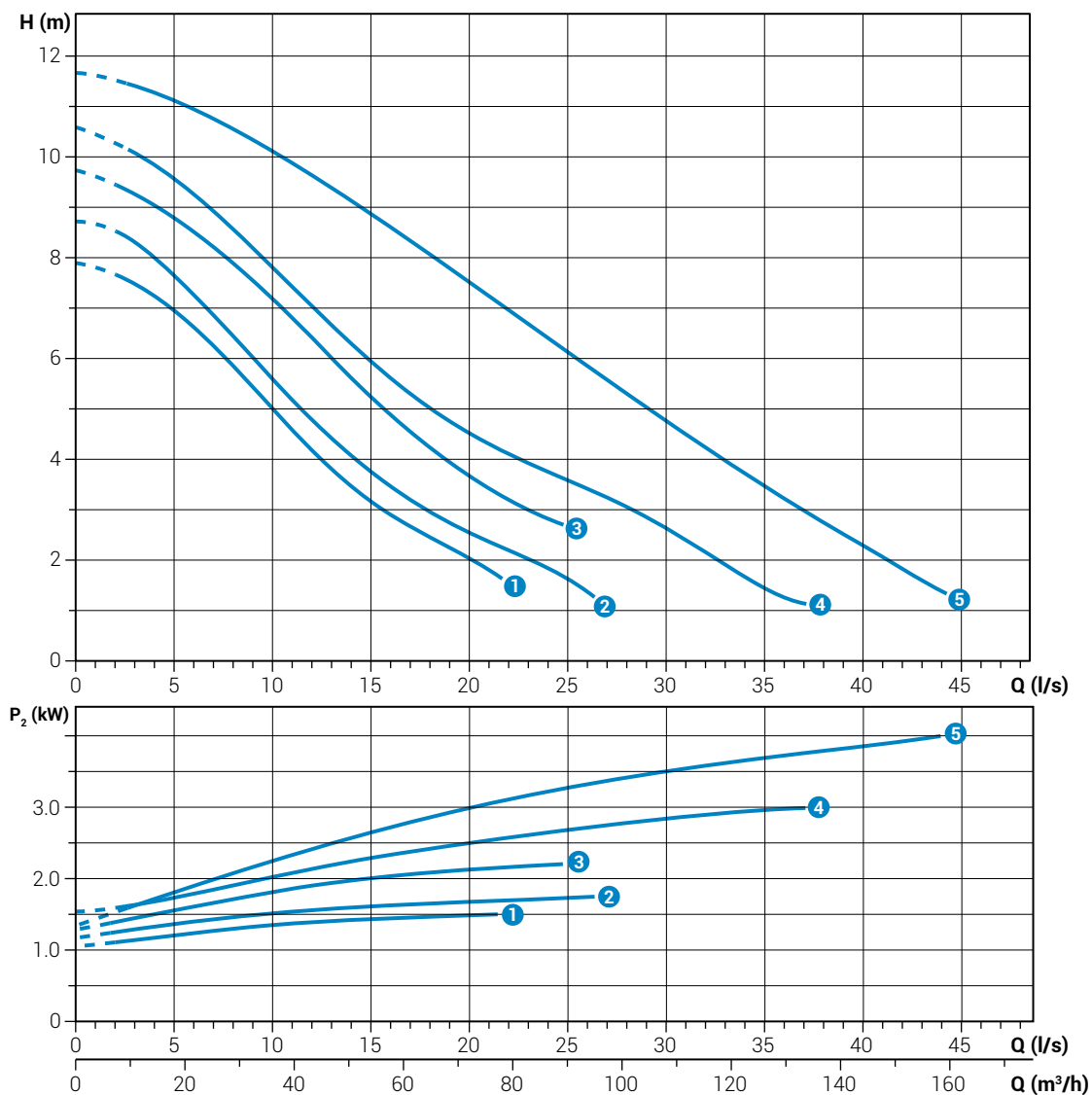

Characteristic curves according to UNI EN ISO 9906

Technical data

	V	Phases	P1 (kw)	P2 (kw)	A	Rpm	Start	Cable	Ø	Free passage	
1	DGG 200/4/100 E0ET5	400	3	1.84	1.5	3.4	1450	Dir	4G1.5+3x1	DN100	100 mm
2	DGG 250/4/100 E0ET5	400	3	2.22	1.8	4.3	1450	Dir	4G1.5+3x1	DN100	100 mm
3	DGG 300/4/100 E0ET5	400	3	2.7	2.2	5.15	1450	Dir	4G1.5+3x1	DN100	100 mm
4	DGG 400/4/100 D0ET5	400	3	3.68	3.0	6.72	1450	Dir	4G1.5+3x1	DN100	100 mm
5	DGG 550/4/100 G0FT5	400	3	4.62	4.0	8.4	1450	Dir	4G1.5+3x1	DN100	80 mm

DGG 750 ÷ 2000/4/100

Performances

	l/s	0	8	16	24	32	40	48	56	64
	l/min	0	480	960	1440	1920	2400	2880	3360	3840
	m ³ /h	0	28.8	57.6	86.4	115.2	144	172.8	201.6	230.4
①	DGG 750/4/100 G0FT5	13.5	12.1	10.4	8.5	6.6	4.4	2.3		
②	DGG 1200/4/100 B0HT5	20.3	18.8	17.2	15.0	12.3	9.3	6.5	3.8	
③	DGG 1500/4/100 B0HT5	22.7	21.1	19.6	17.6	15.0	12.1	9.2	6.4	3.6
④	DGG 2000/4/100 B0HT5	23.5	22.8	21.4	19.5	17.3	14.8	12.1	9.1	6.0

Characteristic curves according to UNI EN ISO 9906

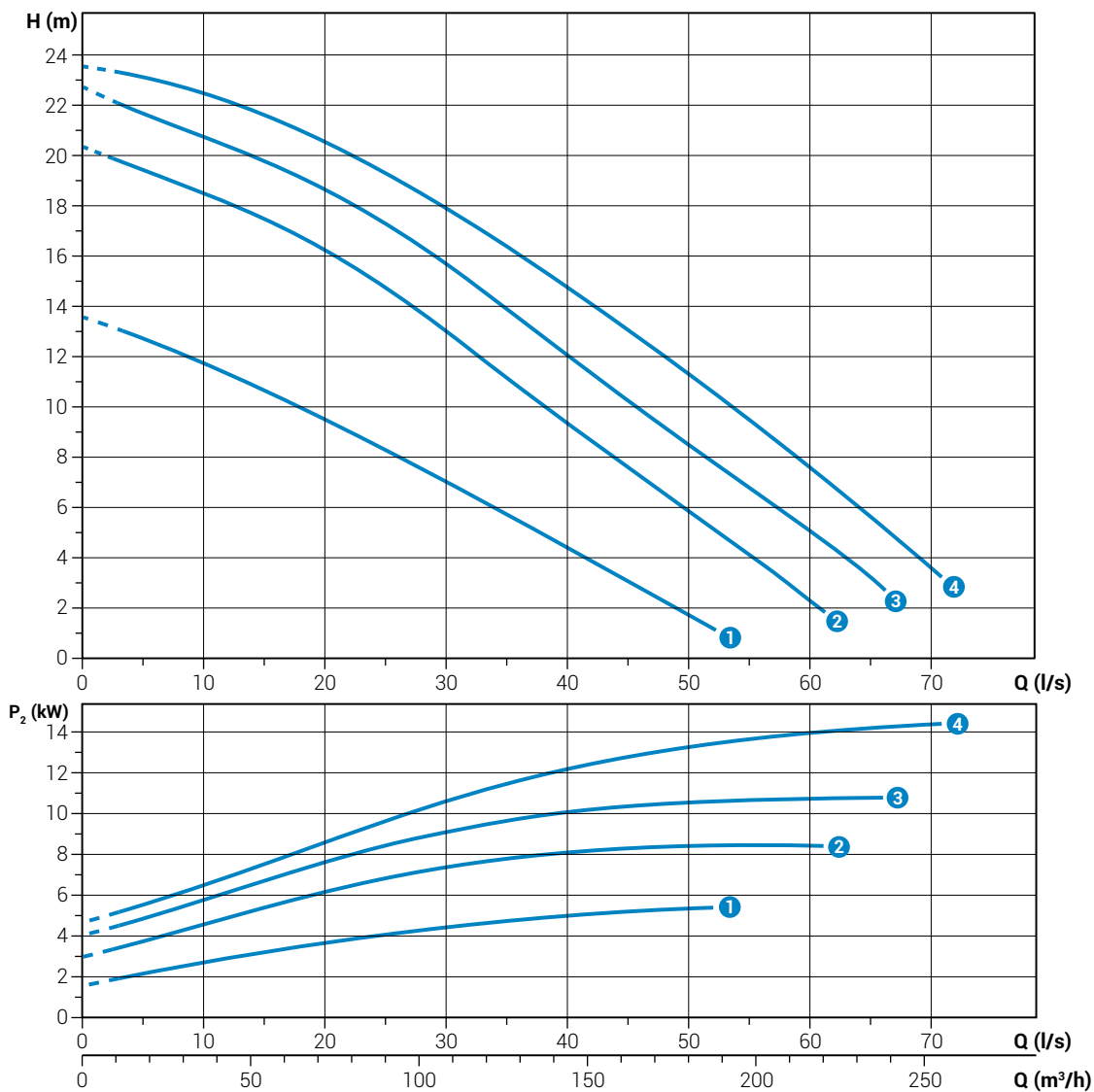

Technical data

	V	Phases	P1 (kW)	P2 (kW)	A	Rpm	Start	Cable	Ø	Free passage	
①	DGG 750/4/100 G0FT5	400	3	6.38	5.5	11.8	1450	Dir	4G1.5+3x1	DN100	80 mm
②	DGG 1200/4/100 B0HT5	400	3	10.2	9.0	17.0	1450	Y Δ	7G1.5+3x1	DN100	100 mm
③	DGG 1500/4/100 B0HT5	400	3	12.6	11.0	20.5	1450	Y Δ	7G1.5+3x1	DN100	100 mm
④	DGG 2000/4/100 B0HT5	400	3	16.7	15.0	30.8	1450	Y Δ	7G1.5+3x1	DN100	100 mm

DGG 1200-1500-2000/4/150

Performances

	l/s	0	8	16	24	32	40	48	56	64	72	80	88	96	104
	l/min	0	480	960	1440	1920	2400	2880	3360	3840	4320	4800	5280	5760	6240
	m ³ /h	0	28,8	57,6	86,4	115,2	144	172,8	201,6	230,4	259,2	288	316,8	345,6	374,4
① DGG 1200/4/150 A0HT5		11.3	10.6	10.1	9.6	9.0	8.2	7.1	5.7	4.2	2.7	1.5	0.8		
② DGG 1500/4/150 A0HT5		13.3	12.4	11.8	11.4	10.9	10.2	9.2	8.0	6.5	4.8	3.3	1.9		
③ DGG 2000/4/150 A0HT5		16.2	15.2	14.5	13.9	13.3	12.6	11.7	10.6	9.2	7.7	6.2	4.6	3.3	2.3

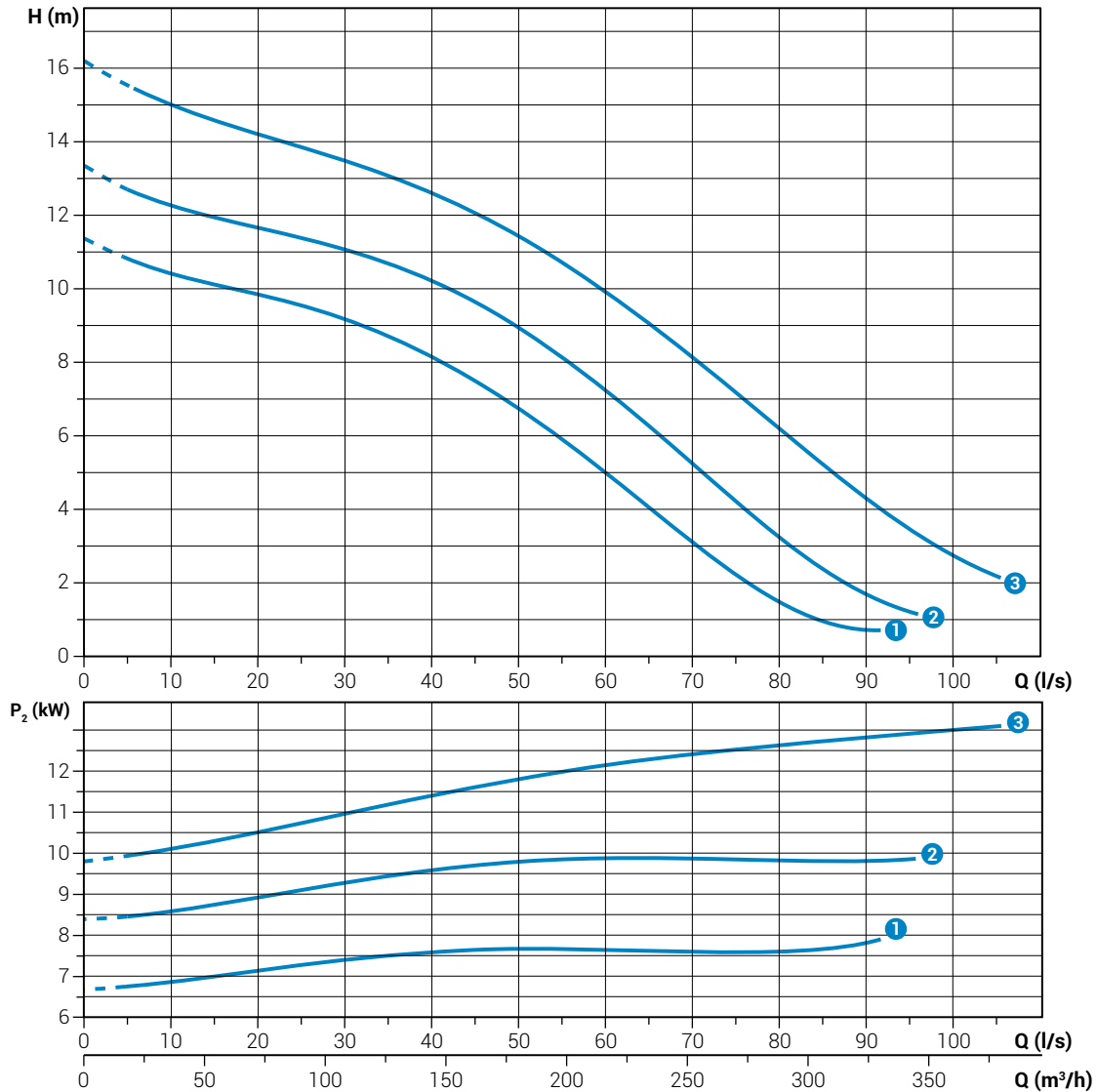

Characteristic curves according to UNI EN ISO 9906

Technical data

	V	Phases	P1 (kw)	P2 (kw)	A	Rpm	Start	Cable	Ø	Free passage
① DGG 1200/4/150 A0HT5	400	3	10.2	9.0	17.0	1450	Y Δ	7G1.5+3x1	DN150	125 mm
② DGG 1500/4/150 A0HT5	400	3	12.6	11.0	20.5	1450	Y Δ	7G1.5+3x1	DN150	125 mm
③ DGG 2000/4/150 A0HT5	400	3	16.7	15.0	30.8	1450	Y Δ	7G2.5+3x1	DN150	125 mm

Overall dimensions and weights

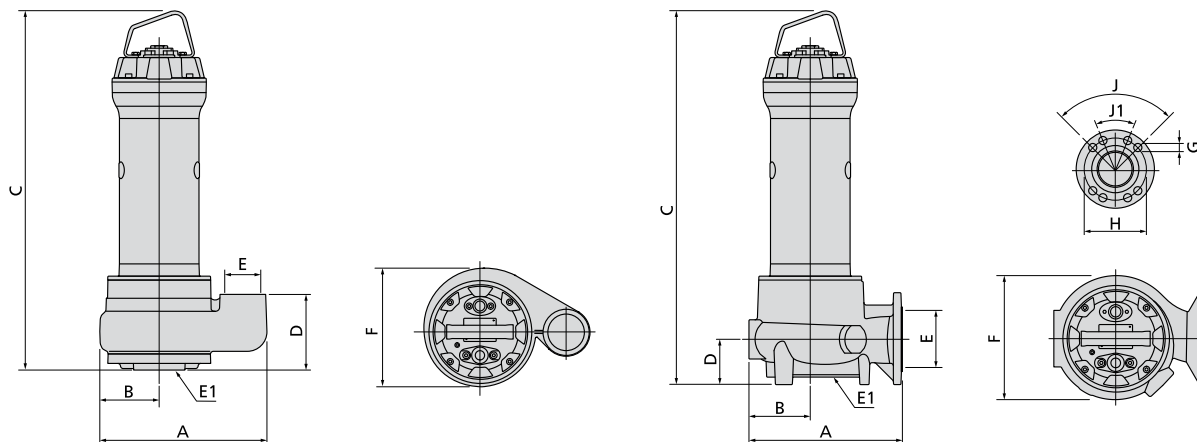

Dimensions in mm

	A	B	C	D	E	E1	F	kg
DGG 250/2/G65V B0AT5	311	109	553	133	2½"	65	219	35.0
DGG 300/2/G65V A0ET5	311	109	576	133	2½"	65	219	59.6

	A	B	C	D	E	E1	F	G	H	J°	J1°	kg
DGG 250/2/65 B0AT5	301	119	553	70	65	65	218	18	145	90	-	37.0
DGG 300/2/65 C0ET5	301	119	576	70	65	65	218	18	145	90	-	61.6
DGG 400/2/65 D0ET5	301	119	626	70	65	65	218	18	145	90	-	64.6
DGG 550/2/65 A0FT5	301	119	733	90	65	65	222	18	145	90	-	70.6
DGG 750/2/65 A0FT5	301	119	733	90	65	65	222	18	145	90	-	73.3
DGG 1000/2/65 A0FT5	301	119	808	90	65	65	222	18	145	90	-	82.3
DGG 250/2/80 F0AT5	312	120	580	80	80	80	236	18	160	90	45	35.0
DGG 300/2/80 G0ET5	312	120	602	80	80	80	236	18	160	90	45	59.6
DGG 400/2/80 H0ET5	312	120	652	80	80	80	236	18	160	90	45	61.6
DGG 550/2/80 N0FT5	313	125	762	92	80	80	251	18	160	90	45	71.0
DGG 750/2/80 A0FT5	313	125	762	92	80	80	251	18	160	90	45	73.7
DGG 1000/2/80 A0FT5	313	125	837	92	80	80	251	18	160	90	45	82.7
DGG 150/4/65 H0AT5	322	129	575	80	65	65	249	18	145	90	-	39.0
DGG 200/4/65 F0ET5	395	158	606	70	65	65	308	18	145	90	-	66
DGG 250/4/65 F0ET5	395	158	656	70	65	65	308	18	145	90	-	68.0
DGG 300/4/65 F0ET5	395	158	656	70	65	65	308	18	145	90	-	70.6
DGG 400/4/65 G0ET5	395	158	656	70	65	65	308	18	145	90	-	75.0
DGG 150/4/80 L0AT5	317	127	580	80	80	80	246	18	160	90	45	39
DGG 200/4/80 E0ET5	389	156	624	80	80	80	306	18	160	90	45	66
DGG 250/4/80 E0ET5	389	156	674	80	80	80	306	18	160	90	45	68.0
DGG 300/4/80 E0ET5	389	156	674	80	80	80	306	18	160	90	45	70.6
DGG 400/4/80 M0ET5	389	156	674	80	80	80	306	18	160	90	45	75.0
DGG 550/4/80 D0FT5	484	194	820	80	80	80	374	18	160	90	45	95.8
DGG 750/4/80 D0FT5	484	194	820	80	80	80	374	18	160	90	45	96.8
DGG 1200/4/80 D0HT5	484	194	968	80	80	80	374	18	160	90	45	186.0
DGG 200/4/100 E0ET5	410	158	645	91	100	100	305	18	180	45	-	69
DGG 250/4/100 E0ET5	410	158	695	91	100	100	305	18	180	45	-	71.0
DGG 300/4/100 E0ET5	410	158	695	91	100	100	305	18	180	45	-	73.6
DGG 400/4/100 D0ET5	410	158	695	91	100	100	305	18	180	45	-	78.0
DGG 550/4/100 G0FT5	408	158	826	91	100	100	305	18	180	45	-	81.8
DGG 750/4/100 G0FT5	408	158	826	91	100	100	305	18	180	45	-	82.8
DGG 1200/4/100 B0HT5	496	190	1032	110	100	100	373	18	180	45	-	193.2
DGG 1500/4/100 B0HT5	496	190	1032	110	100	100	373	18	180	45	-	199.2
DGG 2000/4/100 B0HT5	496	190	1122	110	100	100	373	18	180	45	-	205.2
DGG 1200/4/150 A0HT5	612	222	985	130	150	150	447	24	240	45	-	228.0
DGG 1500/4/150 A0HT5	612	222	985	130	150	150	447	24	240	45	-	234.0
DGG 2000/4/150 A0HT5	612	222	1075	130	150	150	447	24	240	45	-	240.0

DGG

Packaging dimension



	X	Y	Z
DGG 250/2/G65V B0AT5	445	725	425
DGG 300/2/G65V C0ET5	445	725	425
DGG 250/2/65 B0AT5	445	725	425
DGG 300/2/65 C0ET5	445	725	425
DGG 400/2/65 D0ET5	445	725	425
DGG 550/2/65 A0FT5	535	915	560
DGG 750/2/65 A0FT5	535	915	560
DGG 1000/2/65 A0FT5	535	915	560
DGG 250/2/80 F0AT5	445	725	425
DGG 300/2/80 G0ET5	445	725	425
DGG 400/2/80 H0ET5	445	725	425
DGG 550/2/80 N0FT5	535	915	560
DGG 750/2/80 A0FT5	535	915	560
DGG 1000/2/80 A0FT5	535	915	560
DGG 150/4/65 H0AT5	445	725	425
DGG 200/4/65 F0ET5	445	725	425
DGG 250/4/65 F0ET5	445	725	425
DGG 300/4/65 F0ET5	445	725	425
DGG 400/4/65 G0ET5	445	725	425
DGG 150/4/80 L0AT5	445	725	425
DGG 200/4/80 E0ET5	445	725	425
DGG 250/4/80 E0ET5	445	725	425
DGG 300/4/80 E0ET5	445	725	425
DGG 400/4/80 M0ET5	445	725	425
DGG 550/4/80 D0FT5	535	915	560
DGG 750/4/80 D0FT5	535	915	560
DGG 1200/4/80 D0HT5	535	1000	560
DGG 200/4/100 E0ET5	445	725	425
DGG 250/4/100 E0ET5	445	725	425
DGG 300/4/100 E0ET5	445	725	425
DGG 400/4/100 D0ET5	445	725	425
DGG 550/4/100 G0FT5	535	915	560
DGG 750/4/100 G0FT5	535	915	560
DGG 1200/4/100 B0HT5	725	1270	675
DGG 1500/4/100 B0HT5	725	1270	675
DGG 2000/4/100 B0HT5	725	1270	675
DGG 1200/4/150 A0HT5	725	1270	675
DGG 1500/4/150 A0HT5	725	1270	675
DGG 2000/4/150 A0HT5	725	1270	675

Dimensions in mm

Multi-channel open impeller

Operating ranges

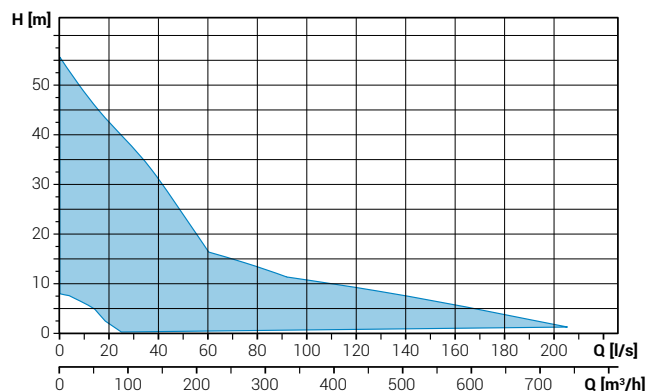

Range characteristics

Motor power	1.8 ÷ 18.5 kW
Poles	2 / 4 / 6
Insulation class	H
Degree of protection	IP68
Discharge	GAS 2½" vertical DN65 ÷ DN250 horizontal
Free passage	max 100 x 70 mm
Max flow rate	205 l/s
Max head	48.3 m

Motor

Ecological dry motor with thermal protections

Cable

S1RN8-F electric cable. Standard version 10 m cable length

Mechanical seals

Two silicon carbide (SiC) mechanical seals in oil sump

Applications

It is particularly suitable for the treatment of liquids containing suspended solids or filaments, and low or medium density activated sludges.

Installations

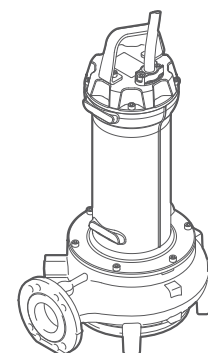
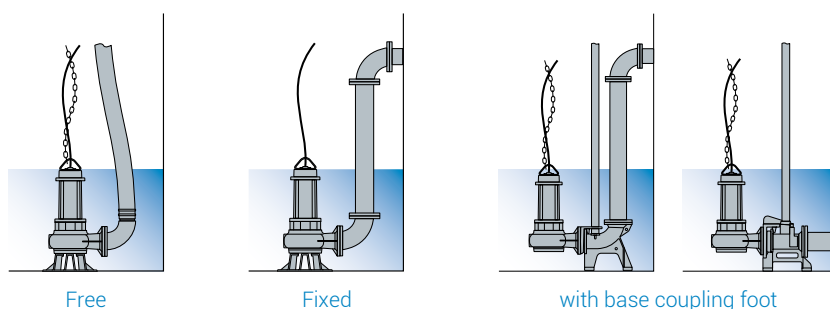

Versions

Electrical variants	NAE, TS
Cooling system	N
Mechanical seals	2SIC

Operating specifications

Max operating temperature	40 °C
PH of treated fluid	6 ÷ 14
Viscosity of treated fluid	1 mm²/s
Maximum immersion depth	20 m
Density of treated fluid	1 Kg/dm³
Acoustic pressure max	<70dB
Max starts per hour	30

Construction materials

Case	Cast iron EN-GJL 250
Hydraulic parts	Cast iron EN-GJL 250
Impeller	Cast iron EN-GJL 250
Nuts and bolts	Stainless steel - Class A2-70
Standard gasket	Rubber - NBR
Shaft	Stainless steel - AISI 431
Paint type	Ecological bicomponent epoxy (~ 200 µm)

DRG 250-300-400/2/G65V

Performances

	l/s	0	4	8	12	16	20	24
	l/min	0	240	480	720	960	1200	1440
	m ³ /h	0	14.4	28.8	43.2	57.6	72	86.4
①	DRG 250/2/G65V B0AT5	17.6	13.9	11.3	8.9	6.1	3.6	
②	DRG 300/2/G65V A0ET5	20.0	16.3	13.8	10.9	8.1	5.7	
③	DRG 400/2/G65V A0ET5	24.6	20.7	17.8	15.0	11.9	9.1	6.4

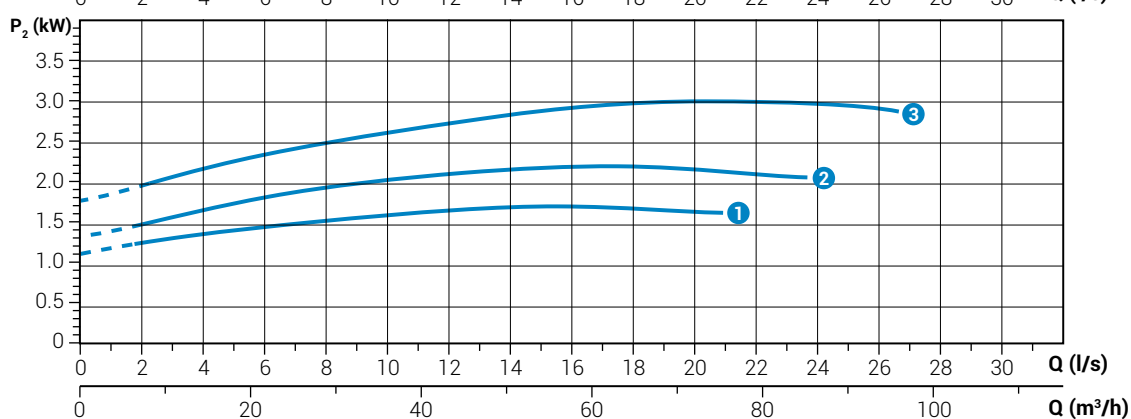
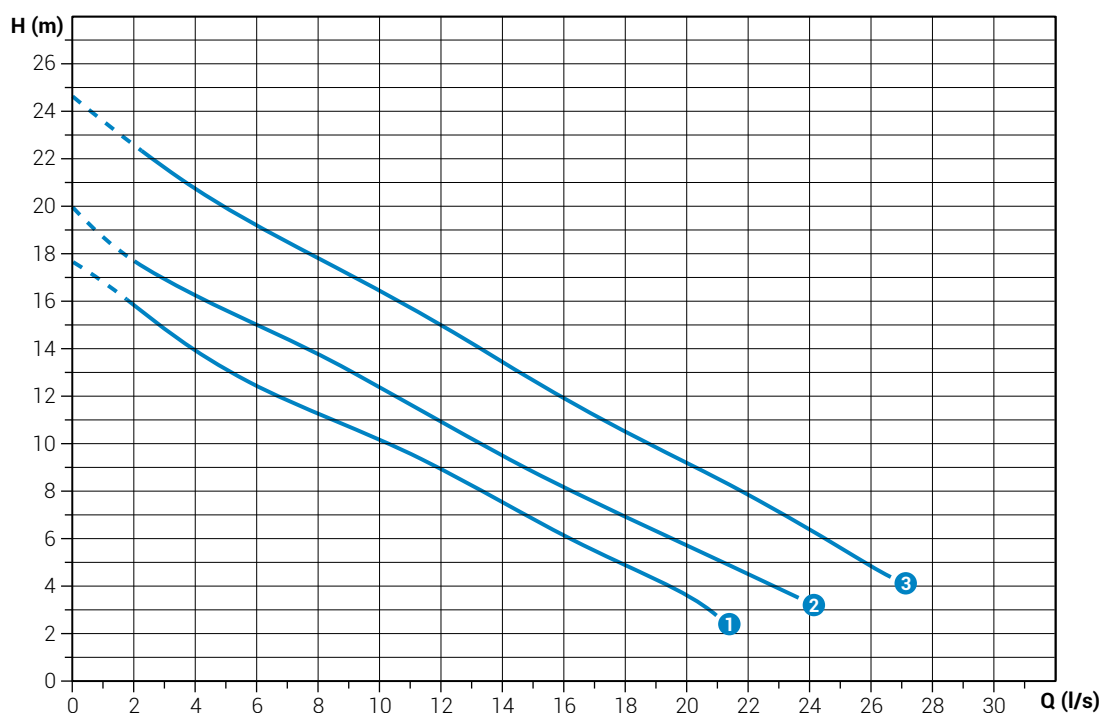

Technical data

	V	Phases	P1 (kw)	P2 (kw)	A	Rpm	Start	Cable	Ø	Free passage	
①	DRG 250/2/G65V B0AT5	400	3	2.19	1.8	3.7	2900	Dir	4G1	G 2½"	35x30 mm
②	DRG 300/2/G65V A0ET5	400	3	2.76	2.2	4.62	2900	Dir	4G1.5+3x1	G 2½"	40x35 mm
③	DRG 400/2/G65V A0ET5	400	3	3.68	3.0	6.36	2900	Dir	4G1.5+3x1	G 2½"	40x35 mm

Characteristic curves according to UNI EN ISO 9906

DRG 150 ÷ 550/2/65**Performances**

	l/s	0	4	8	12	16	20	24	28
	l/min	0	240	480	720	960	1200	1440	1680
	m ³ /h	0	14.4	28.8	43.2	57.6	72.0	86.4	100.8
①	DRG 150/2/65 B0AT5	119	9.7	8.0	6.1	3.9			
②	DRG 200/2/65 B0AT5	15.6	12.6	10.5	8.5	5.8	3.5		
③	DRG 250/2/65 B0AT5	16.7	13.5	11.4	9.5	6.9	4.3		
④	DRG 300/2/65 A0ET5	17.9	15.8	13.6	11.2	8.7	6.1	3.3	
⑤	DRG 400/2/65 A0ET5	22.8	19.9	17.5	15.0	12.5	9.6	6.5	
⑥	DRG 550/2/65 C0FT5	26.4	23.3	20.9	18.8	16.5	13.9	11.1	8.1

Characteristic curves according to UNI EN ISO 9906

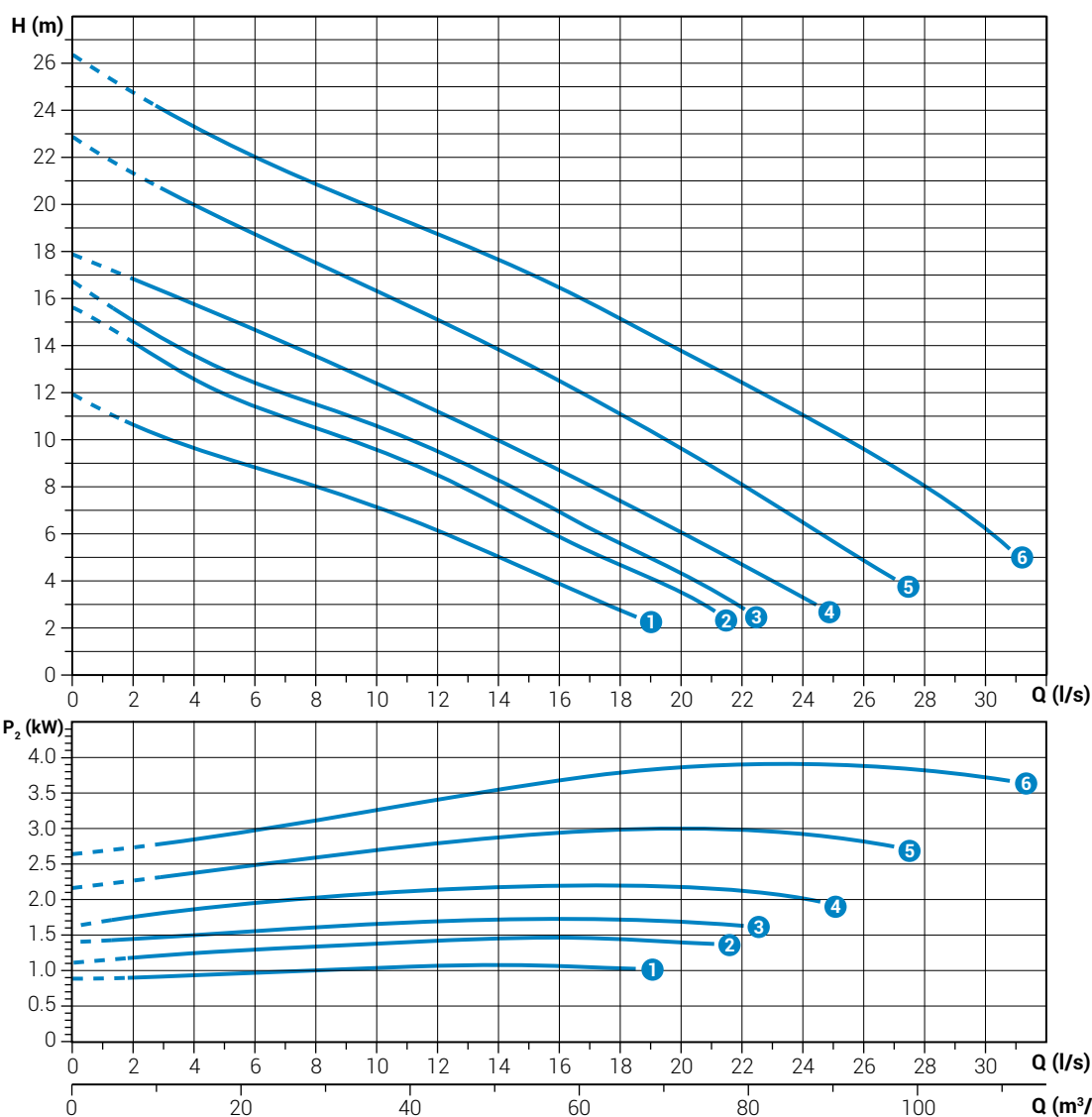
**Technical data**

	V	Phases	P1 (kW)	P2 (kW)	A	Rpm	Start	Cable	Ø	Free passage	
①	DRG 150/2/65 B0AT5	400	3	1.33	1.1	2.43	2900	Dir	4G1.5+3x1	DN65	35x30 mm
②	DRG 200/2/65 B0AT5	400	3	1.82	1.5	3.25	2900	Dir	4G1.5+3x1	DN65	35x30 mm
③	DRG 250/2/65 B0AT5	400	3	2.19	1.8	3.7	2900	Dir	4G1	DN65	35x30 mm
④	DRG 300/2/65 A0ET5	400	3	2.76	2.2	4.62	2900	Dir	4G1.5+3x1	DN65	40x35 mm
⑤	DRG 400/2/65 A0ET5	400	3	3.68	3.0	6.36	2900	Dir	4G1.5+3x1	DN65	40x35 mm
⑥	DRG 550/2/65 C0FT5	400	3	4.66	4.0	7.73	2900	Dir	4G1.5+3x1	DN65	40x35 mm

DRG 250-300-400-550/2/80

Performances

	l/s	0	4	8	12	16	20	24	28
	l/min	0	240	480	720	960	1200	1440	1680
	m ³ /h	0	14.4	28.8	43.2	57.6	72	86.4	100.8
1	DRG 250/2/80 LOAT5	17.0	13.4	11.3	9.2	6.6	4.0	1.3	
2	DRG 300/2/80 E0ET5	18.4	15.9	13.6	11.4	9.1	6.9	4.7	
3	DRG 400/2/80 E0ET5	23.5	20.3	17.7	15.1	12.4	9.6	6.6	3.8
4	DRG 550/2/80 POFT5	26.2	23.3	20.8	18.5	16.1	13.3	10.3	7.0

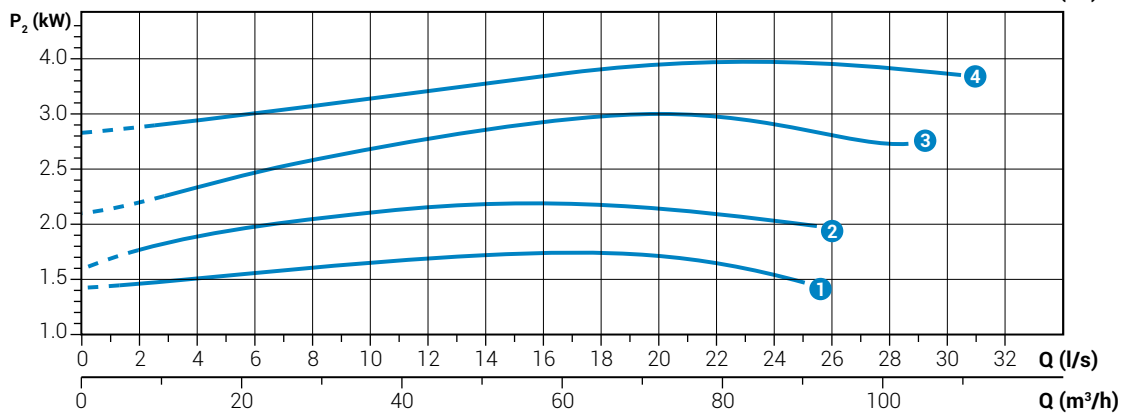
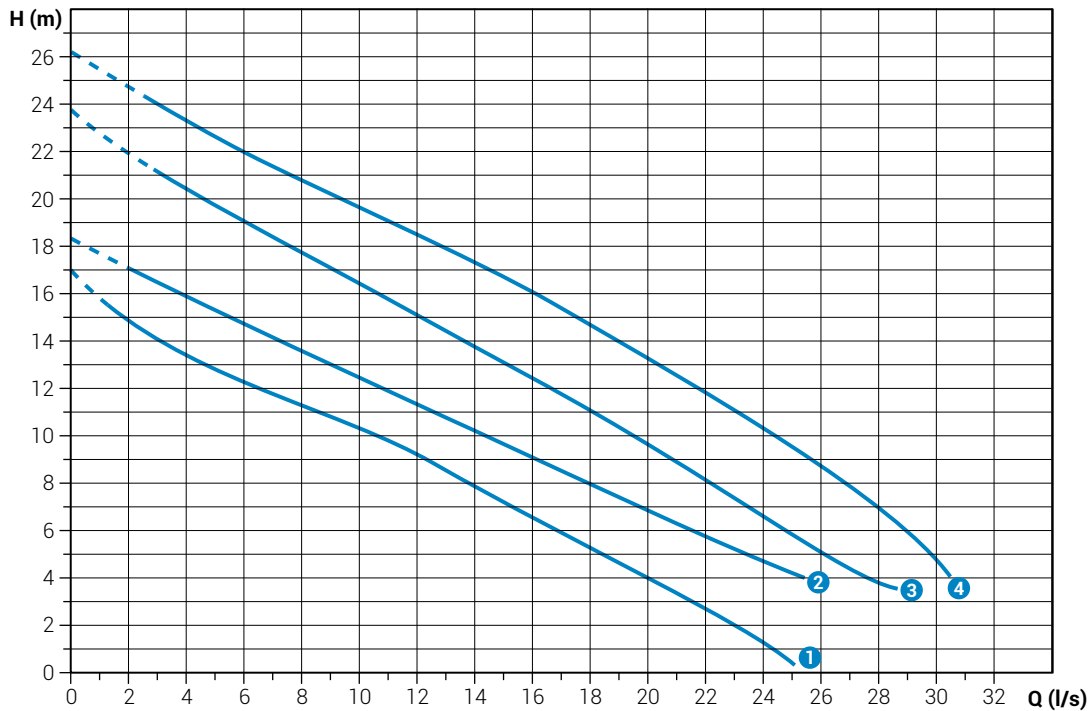

Technical data

	V	Phases	P1 (kw)	P2 (kw)	A	Rpm	Start	Cable	Ø	Free passage	
1	DRG 250/2/80 LOAT5	400	3	2.19	1.8	3.7	2900	Dir	4G1	DN80	35x30 mm
2	DRG 300/2/80 E0ET5	400	3	2.76	2.2	4.62	2900	Dir	4G1.5+3x1	DN80	40x35 mm
3	DRG 400/2/80 E0ET5	400	3	3.68	3.0	6.36	2900	Dir	4G1.5+3x1	DN80	40x35 mm
4	DRG 550/2/80 POFT5	400	3	4.66	4.0	7.73	2900	Dir	4G1.5+3x1	DN80	40x35 mm

Characteristic curves according to UNI EN ISO 9906

DRG 750-1000-1200-1500/2/80 A

Performances

	l/s	0	4	8	12	16	20	24	28	32	36	40	44
	l/min	0	240	480	720	960	1200	1440	1680	1920	2160	2400	2640
	m ³ /h	0	14.4	28.8	43.2	57.6	72	86.4	100.8	115.2	129.6	144	158.4
①	DRG 750/2/80 A0FT5	27.0	24.7	22.0	19.3	16.9	14.7	12.8	10.8	8.6	6.0	2.6	
②	DRG 1000/2/80 A0FT5	38.6	34.2	30.6	27.6	24.7	21.8	19.0	16.3	13.7	11.1	8.3	4.7
③	DRG 1200/2/80 A0GT5	42.8	38.6	35.1	32.1	29.3	26.4	23.2	19.9	16.6	13.4	10.5	7.2
④	DRG 1500/2/80 A0GT5	46.5	41.5	38.5	35.7	32.8	29.6	24.5	23.4	20.2	16.7	13.0	9.5

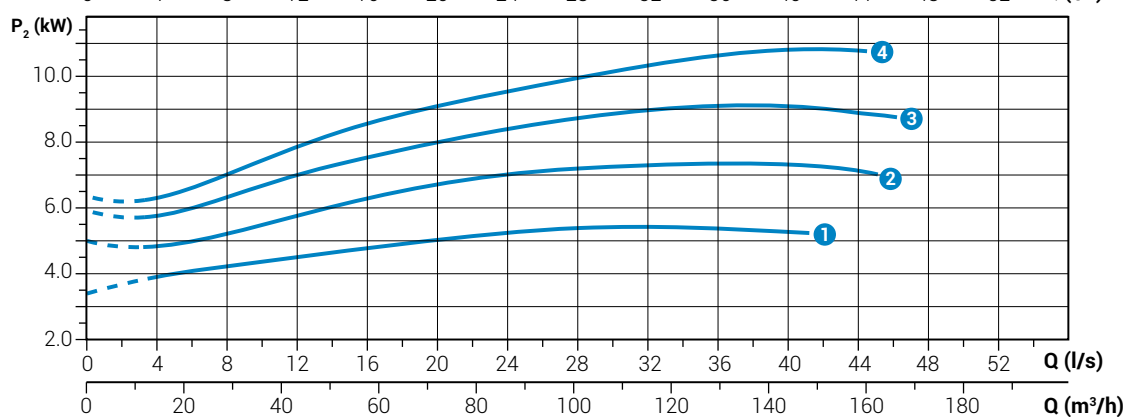
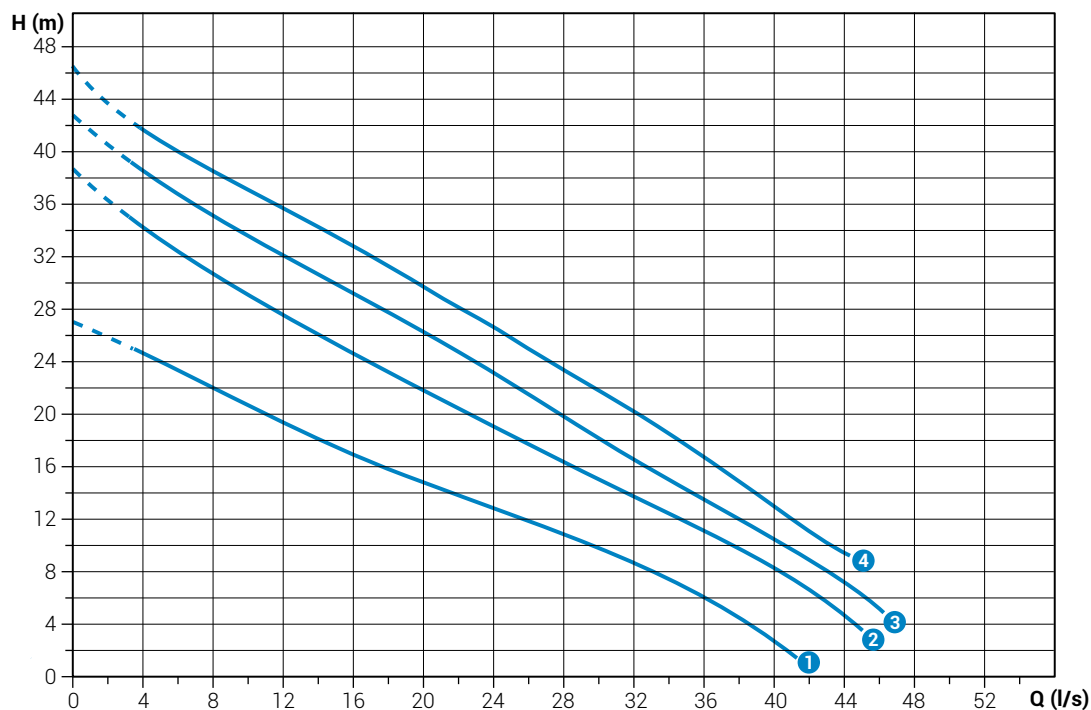

Characteristic curves according to UNI EN ISO 9906

Technical data

	V	Phases	P1 (kW)	P2 (kW)	A	Rpm	Start	Cable	Ø	Free passage	
①	DRG 750/2/80 A0FT5	400	3	6.32	5.5	10.8	2900	Dir	4G1.5+3x1	DN80	40 mm
②	DRG 1000/2/80 A0FT5	400	3	8.51	7.5	13.7	2900	Dir	4G1.5+3x1	DN80	40 mm
③	DRG 1200/2/80 A0GT5	400	3	10.4	9.0	16.1	2900	Y Δ	7G1.5+3x1	DN80	40 mm
④	DRG 1500/2/80 A0GT5	400	3	12.6	11.0	19.5	2900	Y Δ	7G1.5+3x1	DN80	40 mm

DRG 550-750-1000-1200-1500/2/80 B

Performances

	l/s	0	4	8	12	16	20	24	28	32	36	40	44	48
	l/min	0	240	480	720	960	1200	1440	1680	1920	2160	2400	2640	2880
	m ³ /h	0	14.4	28.8	43.2	57.6	72	86.4	100.8	115.2	129.6	144	158.4	172.8
① DRG 550/2/80 B0FT5		18.6	16.3	14.4	12.5	10.7	9.1	7.9	6.9	5.9	4.2			
② DRG 750/2/80 B0FT5		23.4	21.3	19.1	17.0	14.9	13.0	11.1	9.4	7.8	6.1	4.3		
③ DRG 1000/2/80 B0FT5		30.9	28.5	26.0	23.6	21.2	19.0	16.8	14.6	12.4	10.2	7.8	5.6	3.6
④ DRG 1200/2/80 B0GT5		35.0	31.7	28.9	26.5	24.3	22.1	19.8	17.4	14.8	12.4	10.2	8.1	5.9
⑤ DRG 1500/2/80 B0GT5		41.7	36.1	32.8	30.4	28.2	25.9	23.5	21.1	18.8	16.5	14.2	11.9	

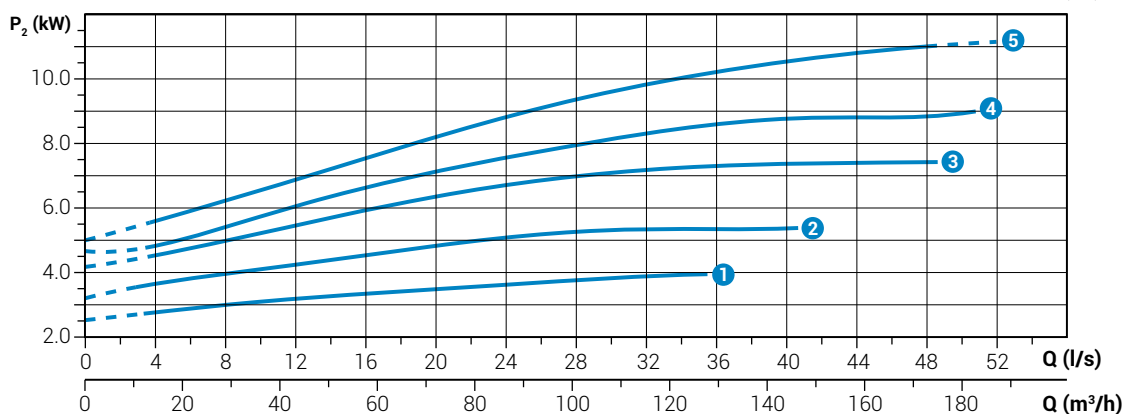
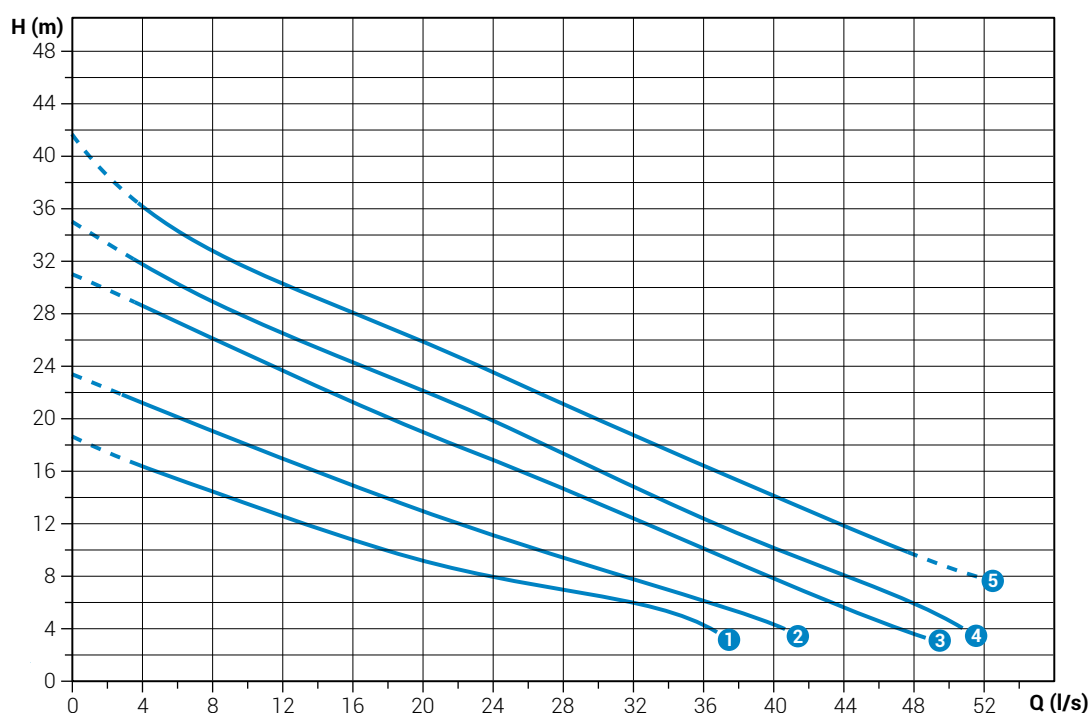

Technical data

	V	Phases	P1 (kW)	P2 (kW)	A	Rpm	Start	Cable	Ø	Free passage
① DRG 550/2/80 B0FT5	400	3	4.66	4.0	7.73	2900	Dir	4G1.5+3x1	DN80	55x50 mm
② DRG 750/2/80 B0FT5	400	3	6.32	5.5	10.8	2900	Dir	4G1.5+3x1	DN80	50x55 mm
③ DRG 1000/2/80 B0FT5	400	3	8.51	7.5	13.7	2900	Dir	4G1.5+3x1	DN80	50x55 mm
④ DRG 1200/2/80 B0GT5	400	3	10.4	9.0	16.1	2900	Y Δ	7G1.5+3x1	DN80	40 mm
⑤ DRG 1500/2/80 B0GT5	400	3	12.6	11.0	19.5	2900	Y Δ	7G1.5+3x1	DN80	40 mm

Characteristic curves according to UNI EN ISO 9906

DRG 2000-2500/2/80 G

Performances

	l/s	0	4	8	12	16	20	24	28	32	36	40	44	48
	l/min	0	240	480	720	960	1200	1440	1680	1920	2160	2400	2640	2880
	m ³ /h	0	14.4	28.8	43.2	57.6	72	86.4	100.8	115.2	129.6	144	158.4	172.8
① DRG 2000/2/80 G0HT5		45.0	41.6	38.1	35.0	32.3	29.9	27.6	25.2	22.6	20.0	17.5	14.9	
② DRG 2500/2/80 G0HT5		48.3	46.0	42.7	39.5	36.8	34.3	32.0	29.5	27.0	24.3	21.7	19.0	15.6

Characteristic curves according to UNI EN ISO 9906

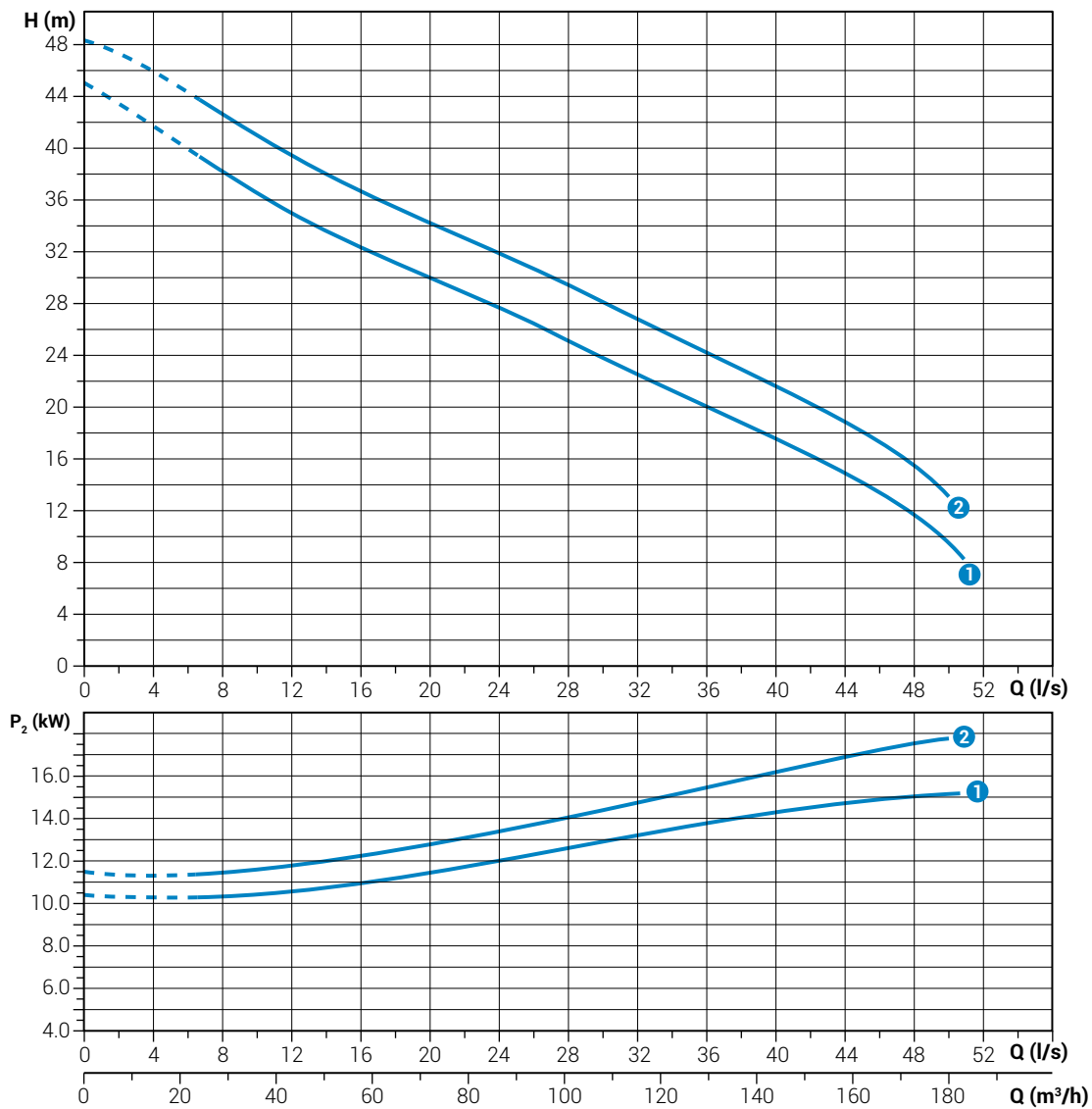

Technical data

	V	Phases	P1 (kW)	P2 (kW)	A	Rpm	Start	Cable	Ø	Free passage
① DRG 2000/2/80 G0HT5	400	3	16.9	15.0	26.2	2900	Y Δ	7G1.5+3x1	DN80	75 mm
② DRG 2500/2/80 G0HT5	400	3	20.7	18.5	32.9	2900	Y Δ	7G2.5+3x1	DN80	75 mm

DRG 2000-2500/2/80 W

Performances

	l/s	0	8	16	24	32	40	48	56	64
	l/min	0	480	960	1440	1920	2400	2880	3360	3840
	m ³ /h	0	28.8	57.6	86.4	115.2	144	172.8	201.6	230.4
①	DRG 2000/2/80 W0HT5	46.7	39.4	35.7	32.1	28.0	23.4	18.5	12.9	6.9
②	DRG 2500/2/80 W0HT5	55.5	49.9	44.7	40.4	36.1	31.1	25.5	19.7	13.7

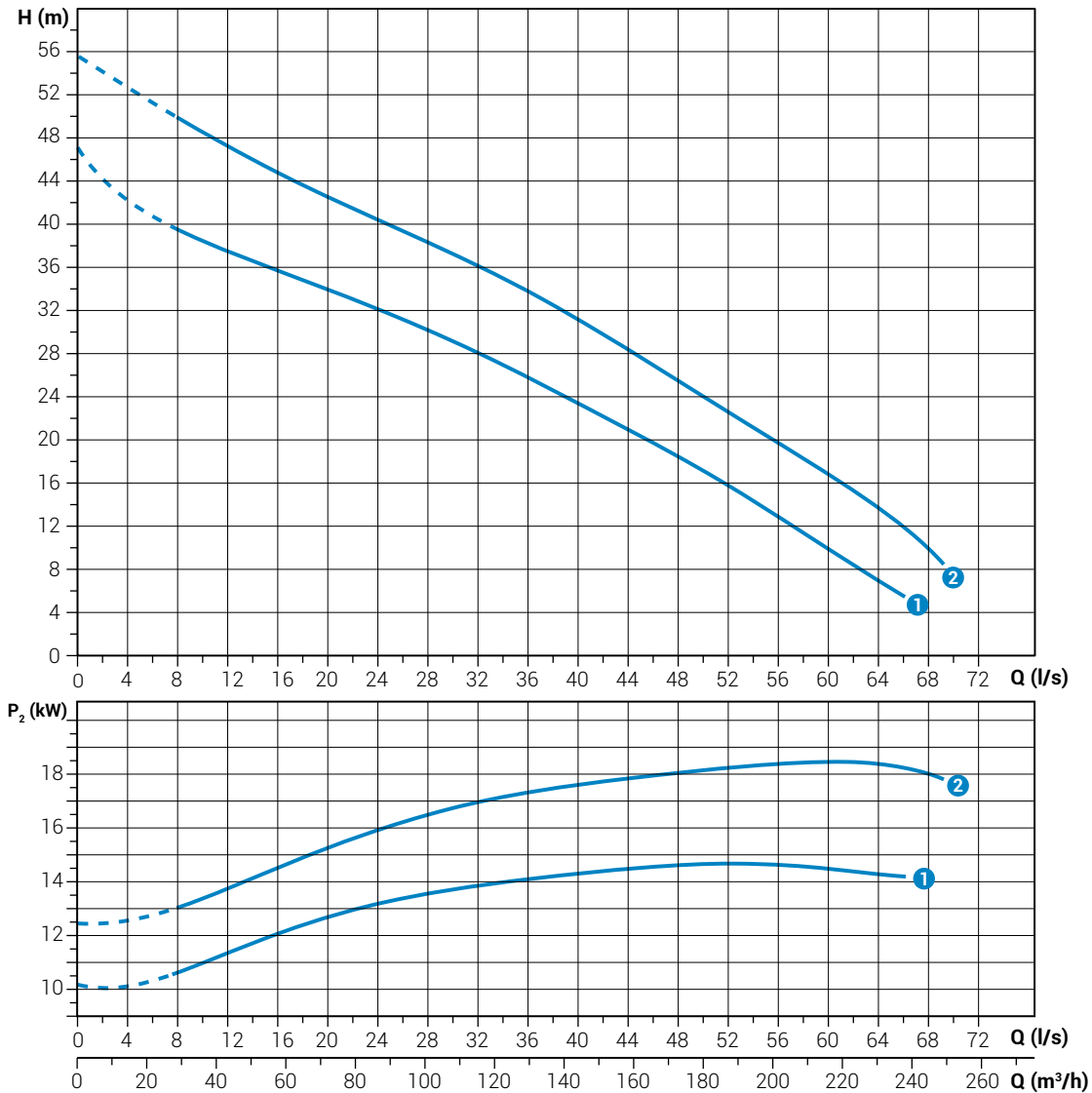

Characteristic curves according to UNI EN ISO 9906

Technical data

	V	Phases	P1 (kw)	P2 (kw)	A	Rpm	Start	Cable	Ø	Free passage	
①	DRG 2000/2/80 W0HT5	400	3	16.9	15.0	26.2	2900	Y Δ	7G1.5+3x1	DN80	45 mm
②	DRG 2500/2/80 W0HT5	400	3	20.7	18.5	32.9	2900	Y Δ	7G2.5+3x1	DN80	45 mm

DRG 1200-1500/2/100

Performances

	l/s	0	8	16	24	32	40	48	56	64
	l/min	0	480	960	1440	1920	2400	2880	3360	3840
	m ³ /h	0	28.8	57.6	86.4	115.2	144	172.8	201.6	230.4
①	DRG 1200/2/100 KOGT5	35.8	31.0	26.2	22.6	19.1	14.8	10.3	6.3	
②	DRG 1500/2/100 KOGT5	38.8	34.2	29.3	25.8	22.2	17.6	12.9	9.1	4.4

Characteristic curves according to UNI EN ISO 9906

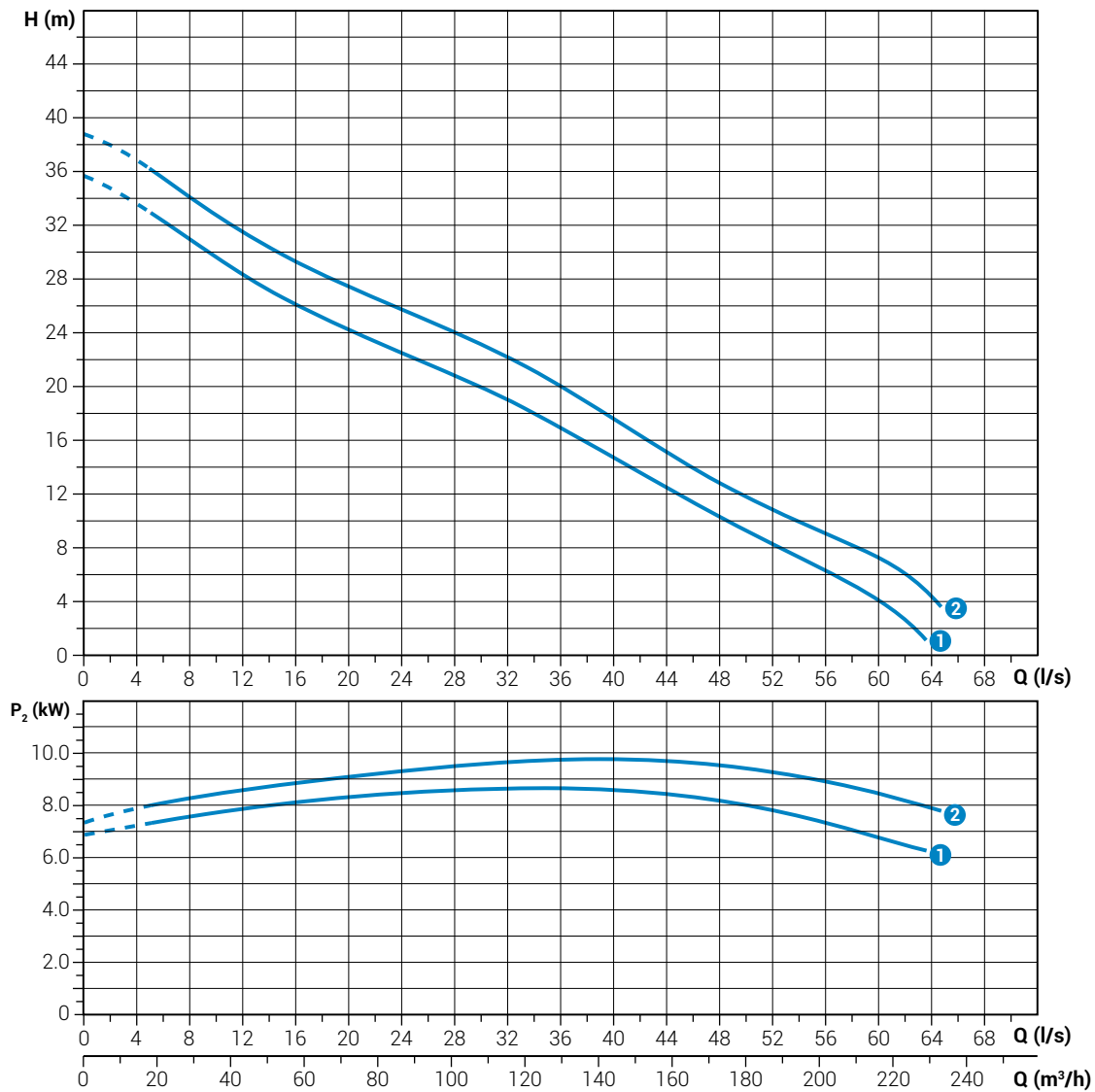

Technical data

	V	Phases	P1 (kW)	P2 (kW)	A	Rpm	Start	Cable	Ø	Free passage	
①	DRG 1200/2/100 KOGT5	400	3	10.4	9.0	16.1	2900	Y Δ	7G1.5+3x1	DN100	45 mm
②	DRG 1500/2/100 KOGT5	400	3	12.6	11.0	19.5	2900	Y Δ	7G1.5+3x1	DN100	45 mm

DRG 200-300-400/4/80

Performances

	l/s	0	4	8	12	16	20	24	28	32
	l/min	0	240	480	720	960	1200	1440	1680	1920
	m ³ /h	0	14.4	28.8	43.2	57.6	72	86.4	100.8	115.2
① DRG 200/4/80 M0ET5		8.6	7.7	6.7	5.6	4.4	2.9	1.3		
② DRG 300/4/80 G0ET5		12.8	11.6	10.2	8.8	7.5	6.3	4.9	3.4	1.6
③ DRG 400/4/80 H0ET5		14.6	13.4	12.0	10.6	9.2	7.8	6.4	4.8	3.0

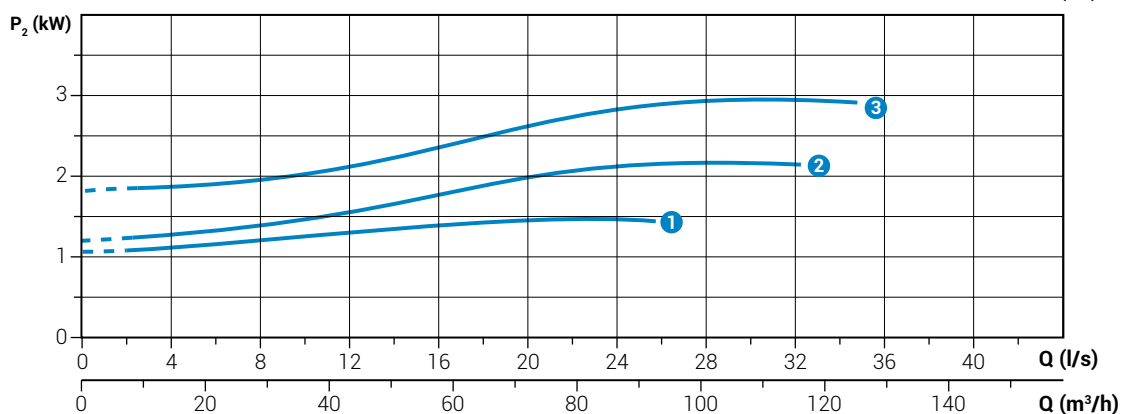
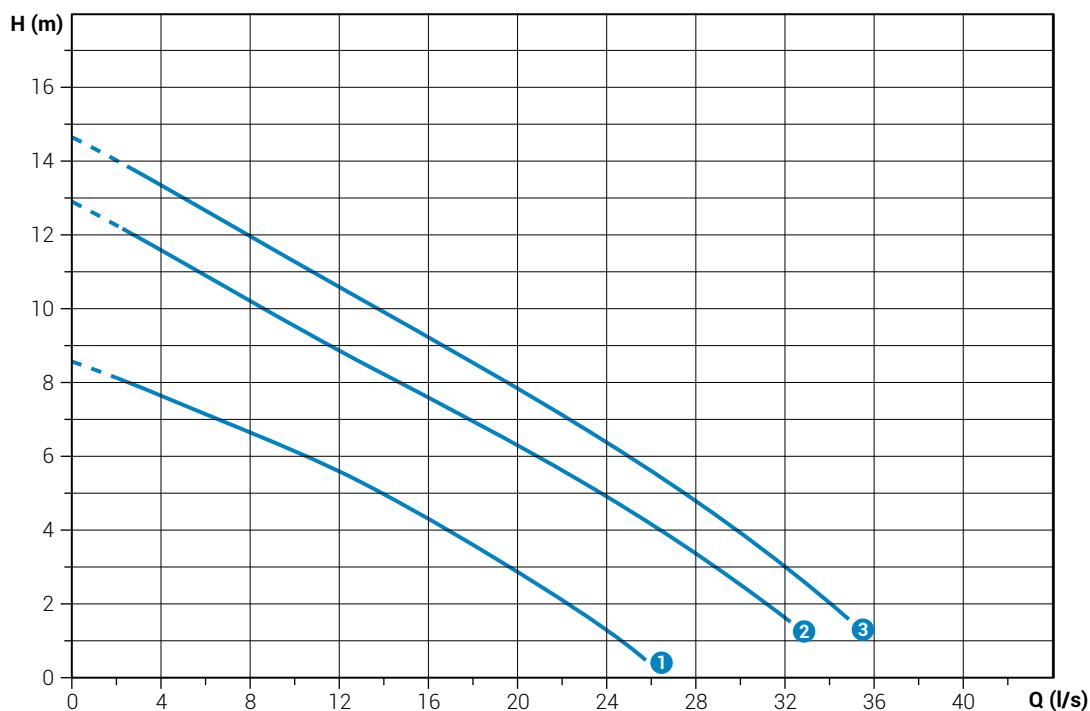

Technical data

	V	Phases	P1 (kW)	P2 (kW)	A	Rpm	Start	Cable	Ø	Free passage
① DRG 200/4/80 M0ET5	400	3	1.84	1.5	3.4	1450	Dir	4G1.5+3x1	DN80	45 mm
② DRG 300/4/80 G0ET5	400	3	2.7	2.2	5.15	1450	Dir	4G1.5+3x1	DN80	75 mm
③ DRG 400/4/80 H0ET5	400	3	3.68	3.0	6.72	1450	Dir	4G1.5+3x1	DN80	75 mm

Characteristic curves according to UNI EN ISO 9906

DRG 550 ÷ 1200/4/80**Performances**

	l/s	0	4	8	12	16	20	24	28	32	36	40	44	48	52
	l/min	0	240	480	720	960	1200	1440	1680	1920	2160	2400	2640	2880	3120
	m ³ /h	0	14.4	28.8	43.2	57.6	72	86.4	100.8	115.2	129.6	144	158.4	172.8	187.2
① DRG 550/4/80 D0FT5		14.7	12.6	12.0	11.5	10.9	10.0	9.1	8.1	7.1	6.1	4.9	3.6	2.1	0.6
② DRG 750/4/80 D0FT5		18.4	17.0	16.0	15.1	14.3	13.4	12.5	11.5	10.3	9.0	7.7	6.3	4.9	3.5
③ DRG 1000/4/80 D0GT5		22.0	21.0	20.0	19.1	18.3	17.4	16.4	15.3	14.1	12.7	11.3	9.9	8.4	6.9
④ DRG 1200/4/80 D0HT5		24.6	23.2	22.2	21.4	20.6	19.7	18.8	17.7	16.6	15.3	14.0	12.6	1.1	9.6

Characteristic curves according to UNI EN ISO 9906

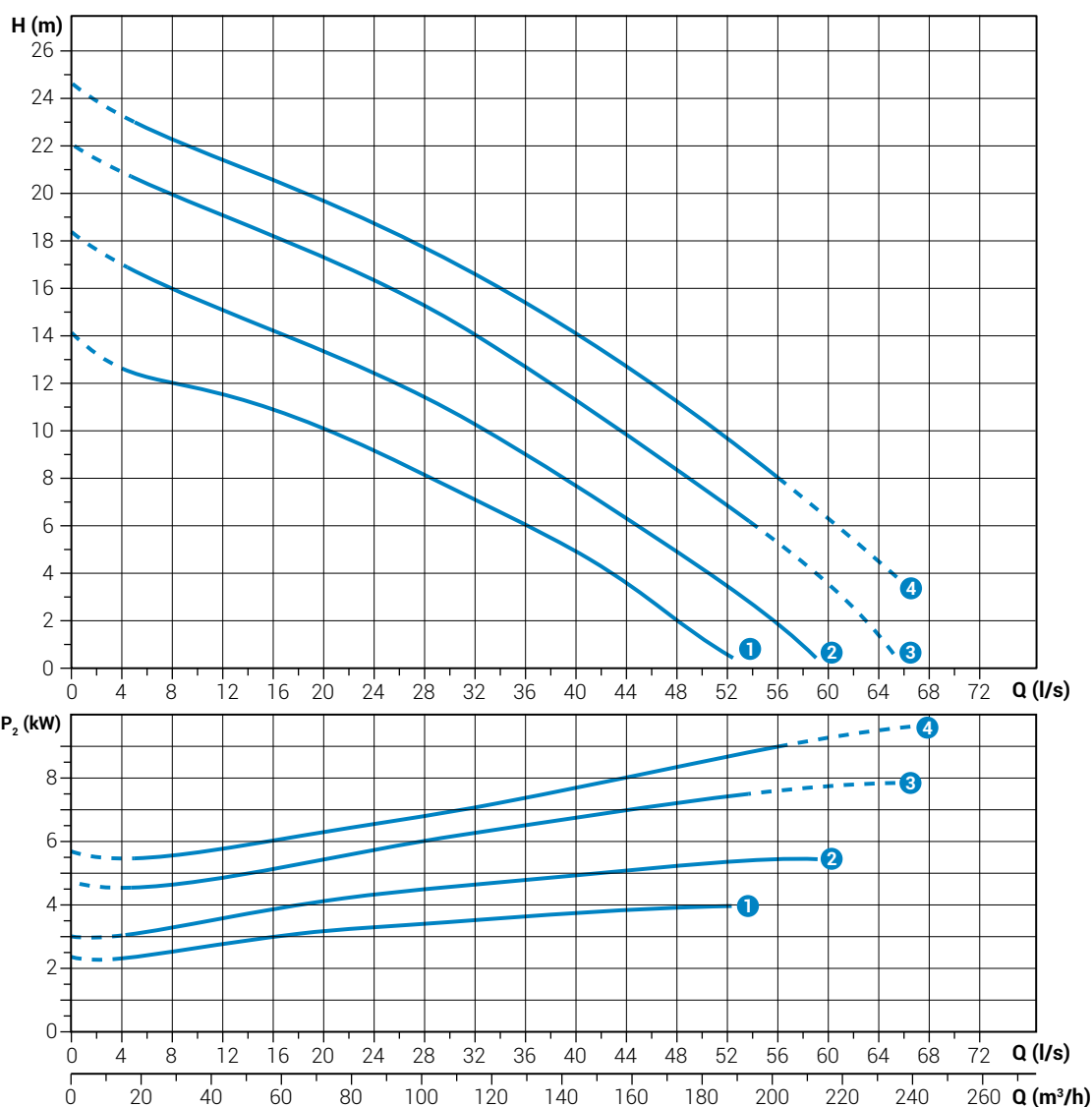
**Technical data**

	V	Phases	P1 (kW)	P2 (kW)	A	Rpm	Start	Cable	Ø	Free passage
① DRG 550/4/80 D0FT5	400	3	4.62	4.0	8.4	1450	Dir	4G1.5+3x1	DN80	65x60 mm
② DRG 750/4/80 D0FT5	400	3	6.38	5.5	11.8	1450	Dir	4G1.5+3x1	DN80	65x60 mm
③ DRG 1000/4/80 D0GT5	400	3	8.72	7.5	15.8	1450	Y Δ	7G1.5+3x1	DN80	65x60 mm
④ DRG 1200/4/80 D0HT5	400	3	10.2	9.0	17.0	1450	Y Δ	7G1.5+3x1	DN80	65x60 mm

DRG 200-300-400/4/100

Performances

	l/s	0	4	8	12	16	20	24	28	32	36	40
	l/min	0	240	480	720	960	1200	1440	1680	1920	2160	2400
	m ³ /h	0	14.4	28.8	43.2	57.6	72	86.4	100.8	115.2	129.6	144
①	DRG 200/4/100 T0ET5	8.7	7.9	6.8	5.7	4.7	3.8	2.4	1.2			
②	DRG 300/4/100 U0ET5	9.9	9.2	8.4	7.5	6.6	5.7	4.7	3.5	2.3	1.0	
③	DRG 400/4/100 U0ET5	11.8	11.1	10.2	9.2	8.3	7.3	6.4	5.4	4.3	3.0	1.6

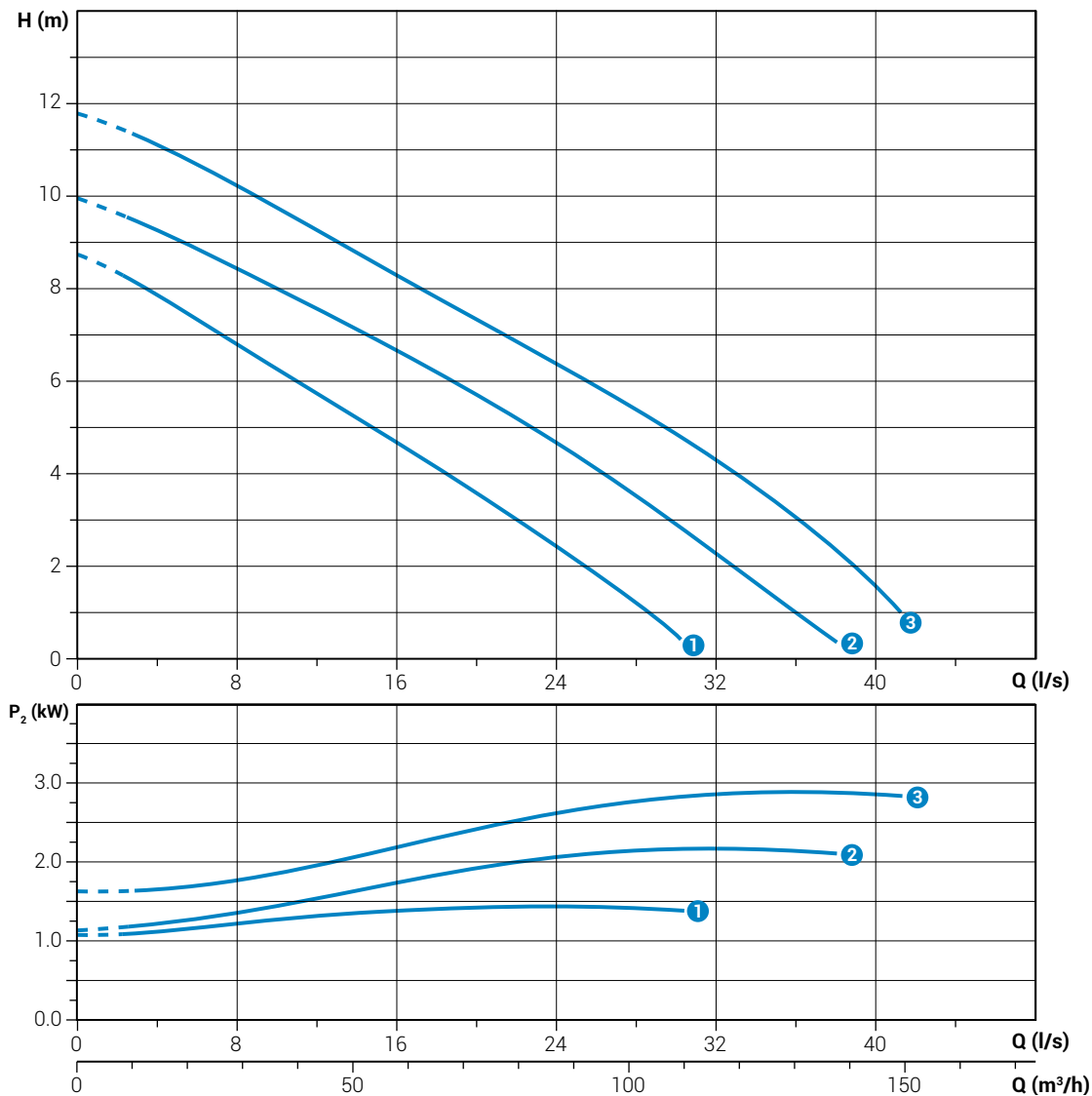

Characteristic curves according to UNI EN ISO 9906

Technical data

	V	Phases	P1 (kw)	P2 (kw)	A	Rpm	Start	Cable	Ø	Free passage	
①	DRG 200/4/100 T0ET5	400	3	1.84	1.5	3.4	1450	Dir	4G1.5+3x1	DN100	45 mm
②	DRG 300/4/100 U0ET5	400	3	2.7	2.2	5.15	1450	Dir	4G1.5+3x1	DN100	60 mm
③	DRG 400/4/100 U0ET5	400	3	3.68	3.0	6.72	1450	Dir	4G1.5+3x1	DN100	60 mm

DRG 300-400/4/100**Performances**

	l/s	0	4	8	12	16	20	24	28	32	36
	l/min	0	240	480	720	960	1200	1440	1680	1920	2160
	m ³ /h	0	14.4	28.8	43.2	57.6	72	86.4	100.8	115.2	129.6
①	DRG 300/4/100 XOET5	12.0	10.6	9.1	7.7	6.6	5.4	4.0	2.5	0.7	
②	DRG 400/4/100 YOET5	14.3	13.0	11.4	9.9	8.6	7.4	6.0	4.6	3.0	1.4

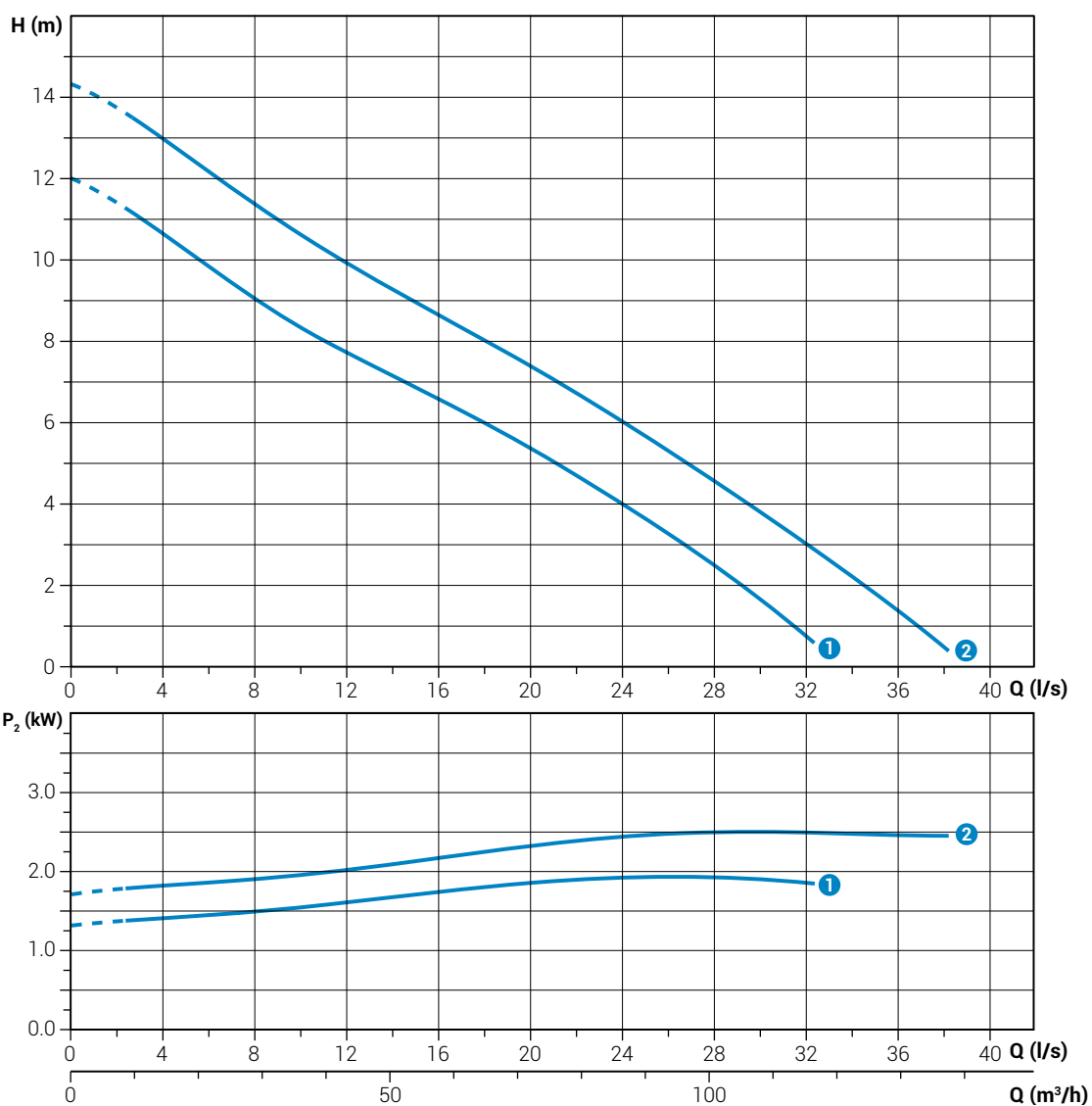
**Technical data**

	V	Phases	P1 (kW)	P2 (kW)	A	Rpm	Start	Cable	Ø	Free passage	
①	DRG 300/4/100 XOET5	400	3	2.7	2.2	5.15	1450	Dir	4G1.5+3x1	DN100	75 mm
②	DRG 400/4/100 YOET5	400	3	3.68	3.0	6.72	1450	Dir	4G1.5+3x1	DN100	75 mm

DRG 550-750-1000-1200/4/100

Performances

	l/s	0	8	16	24	32	40	48	56	64	72	
	l/min	0	480	960	1440	1920	2400	2880	3360	3840	4320	4800
	m ³ /h	0	28.8	57.6	86.4	115.2	144	172.8	201.6	230.4	259.2	288
1	DRG 550/4/100 ROFT5	15.6	12.5	11.2	10.0	8.8	7.4	5.8	4.2			
2	DRG 750/4/100 LOFT5	16.9	14.7	13.3	11.9	10.4	8.7	7.0	5.0	2.8		
3	DRG 1000/4/100 LOGT5	21.4	19.1	17.6	16.1	14.4	12.5	10.5	8.5	6.2	3.6	
4	DRG 1200/4/100 HOHT5	22.4	20.0	18.0	16.4	14.8	13.3	11.6	9.6	7.2	4.4	1.3

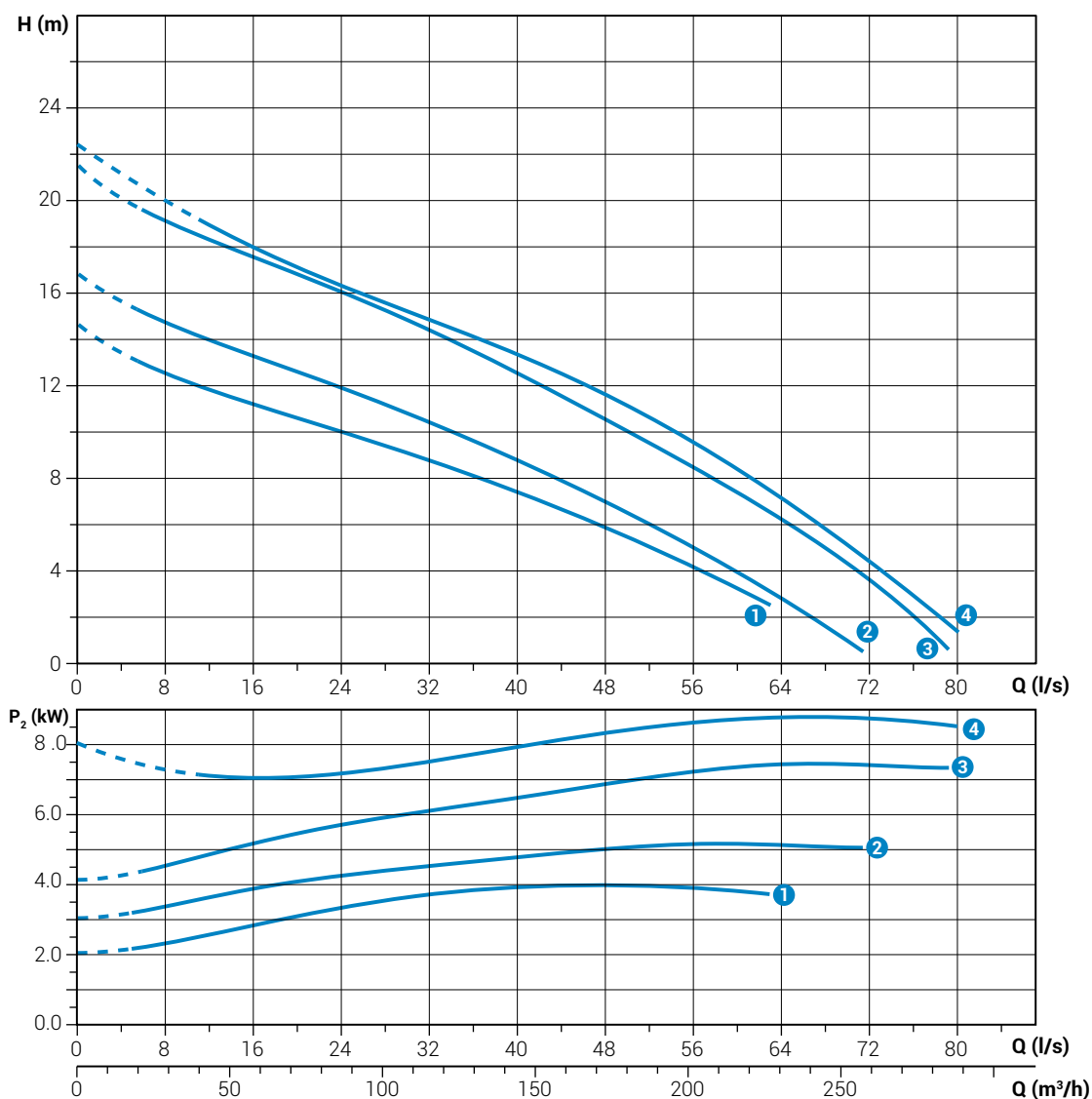

Characteristic curves according to UNI EN ISO 9906

Technical data

	V	Phases	P1 (kw)	P2 (kw)	A	Rpm	Start	Cable	Ø	Free passage	
1	DRG 550/4/100 ROFT5	400	3	4.62	4.0	8.4	1450	Dir	4G1.5+3x1	DN100	65 mm
2	DRG 750/4/100 LOFT5	400	3	6.38	5.5	11.8	1450	Dir	4G1.5+3x1	DN100	65x60 mm
3	DRG 1000/4/100 LOGT5	400	3	8.72	7.5	15.8	1450	Dir	7G1.5+3x1	DN100	65x60 mm
4	DRG 1200/4/100 HOHT5	400	3	10.2	9.0	17	1450	YΔ	7G1.5+3x1	DN100	80 mm

DRG 1500-2000/4/100

Performances

	l/s	0	8	16	24	32	40	48	56	64	72	80	88	96
	l/min	0	480	960	1440	1920	2400	2880	3360	3840	4320	4800	5280	5760
	m ³ /h	0	28.8	57.6	86.4	115.2	144	172.8	201.6	230.4	259.2	288	316.8	345.6
①	DRG 1500/4/100 A0HT5	18.2	17.5	16.8	15.9	14.8	13.5	12.0	10.4	8.5	6.5	4.0		
②	DRG 2000/4/100 A0HT5	26.6	25.4	23.8	22.0	20.3	18.7	17.1	15.5	13.6	11.5	8.9	5.8	

Characteristic curves according to UNI EN ISO 9906

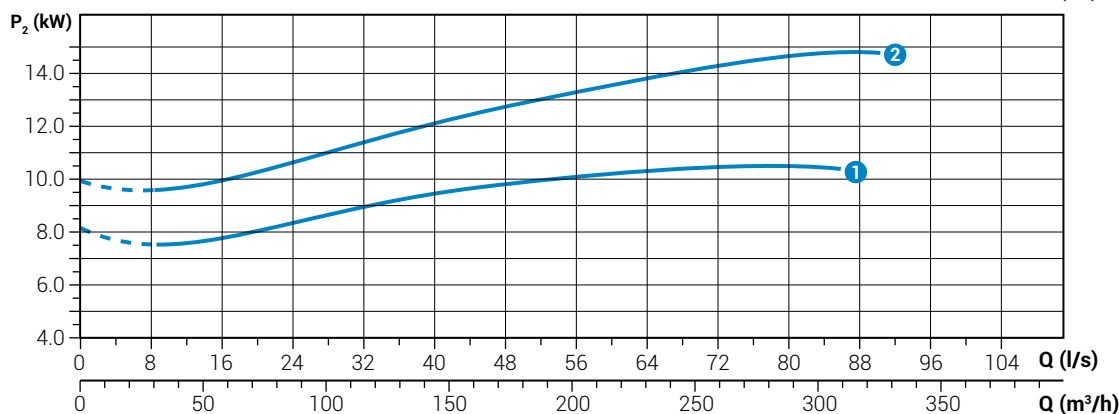
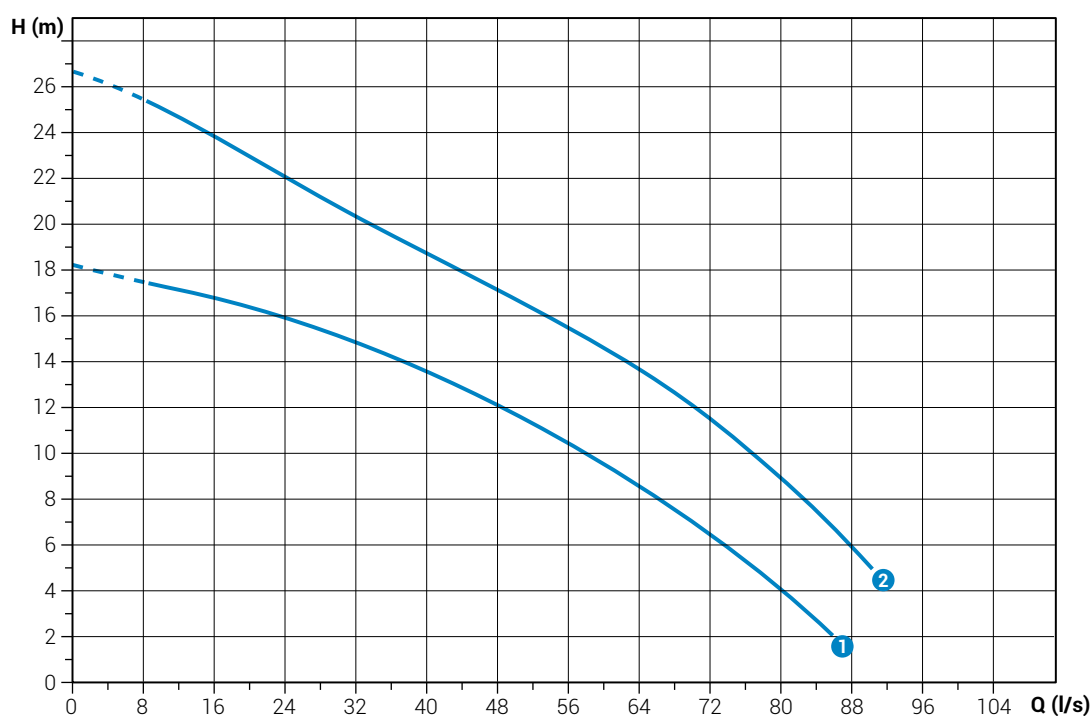

Technical data

	V	Phases	P1 (kW)	P2 (kW)	A	Rpm	Start	Cable	Ø	Free passage	
①	DRG 1500/4/100 A0HT5	400	3	12.6	11.0	20.5	1450	Y Δ	7G1.5+3x1	DN100	80 mm
②	DRG 2000/4/100 A0HT5	400	3	16.7	15.0	30.8	1450	Y Δ	7G2.5+3x1	DN100	80 mm

DRG 1200-2000/4/100

Performances

	l/s	0	8	16	24	32	40	48	56	64	72	80	88	96
	l/min	0	480	960	1440	1920	2400	2880	3360	3840	4320	4800	5280	5760
	m ³ /h	0	28.8	57.6	86.4	115.2	144	172.8	201.6	230.4	259.2	288	316.8	345.6
①	DRG 1200/4/100 LOHT5	23.1	20.7	19.2	17.7	16.0	14.2	12.2	10.1	7.9	5.3	2.2		
②	DRG 2000/4/100 BOHT5	20.7	20.2	19.4	18.3	17.2	15.9	14.6	13.2	11.7	10.2	8.4	6.5	4.3

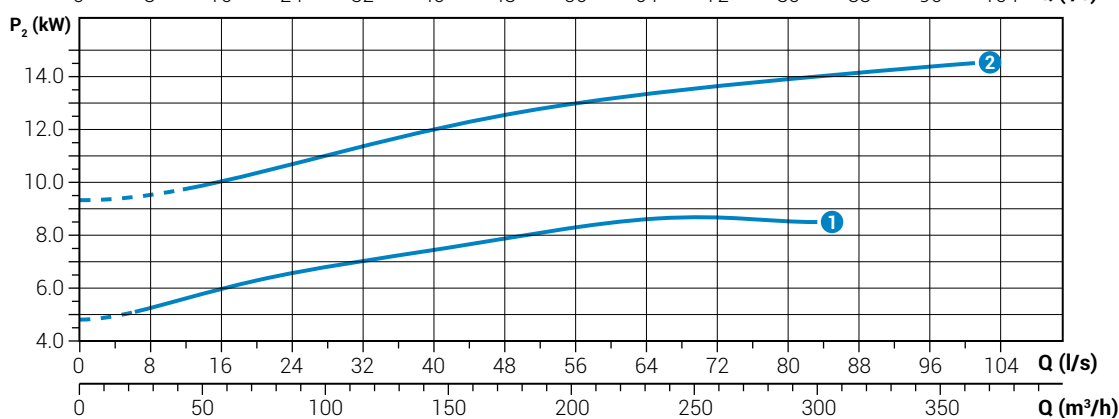
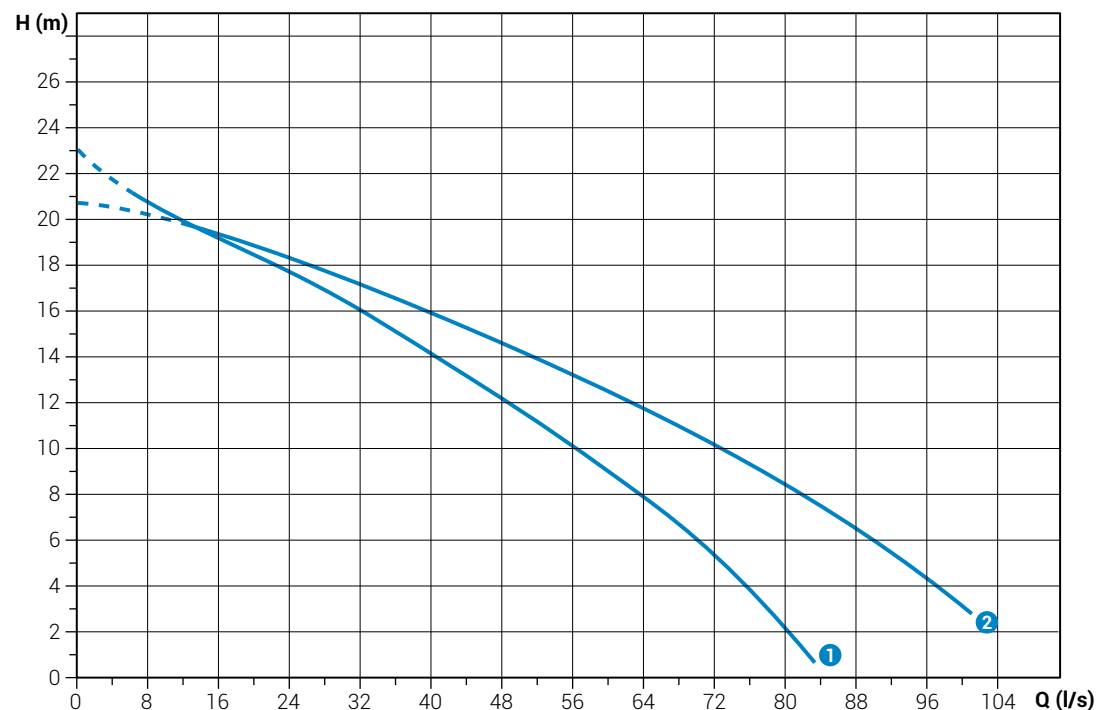

Technical data

	V	Phases	P1 (kW)	P2 (kW)	A	Rpm	Start	Cable	Ø	Free passage	
①	DRG 1200/4/100 LOHT5	400	3	10.2	9.0	17.0	1450	Y Δ	7G1.5+3x1	DN100	65x60
②	DRG 2000/4/100 BOHT5	400	3	16.7	15.0	30.8	1450	Y Δ	7G2.5+3x1	DN100	80 mm

Characteristic curves according to UNI EN ISO 9906

DRG 550-750-1000-1200/4/150**Performances**

	l/s	0	8	16	24	32	40	48	56	64	72	80	88	96	104
	l/min	0	480	960	1440	1920	2400	2880	3360	3840	4320	4800	5280	5760	6240
	m ³ /h	0	28.8	57.6	86.4	115.2	144	172.8	201.6	230.4	259.2	288	316.8	345.6	374.4
① DRG 550/4/150 NOFT5		13.3	11.3	10.3	9.5	8.6	7.5	6.4	5.4	4.2	3.0	1.6			
② DRG 750/4/150 NOFT5		16.3	14.0	12.7	11.7	10.6	9.5	8.2	7.0	5.7	4.4	3.0	1.4		
③ DRG 1000/4/150 NOGT5		20.8	18.5	16.8	15.5	14.3	13.0	11.7	10.3	8.8	7.2	5.7	4.1	2.3	
④ DRG 1200/4/150 NOHT5		22.5	20.2	18.5	17.1	15.9	14.6	13.2	11.8	10.3	8.7	7.1	5.4	3.7	1.6

Characteristic curves according to UNI EN ISO 9906

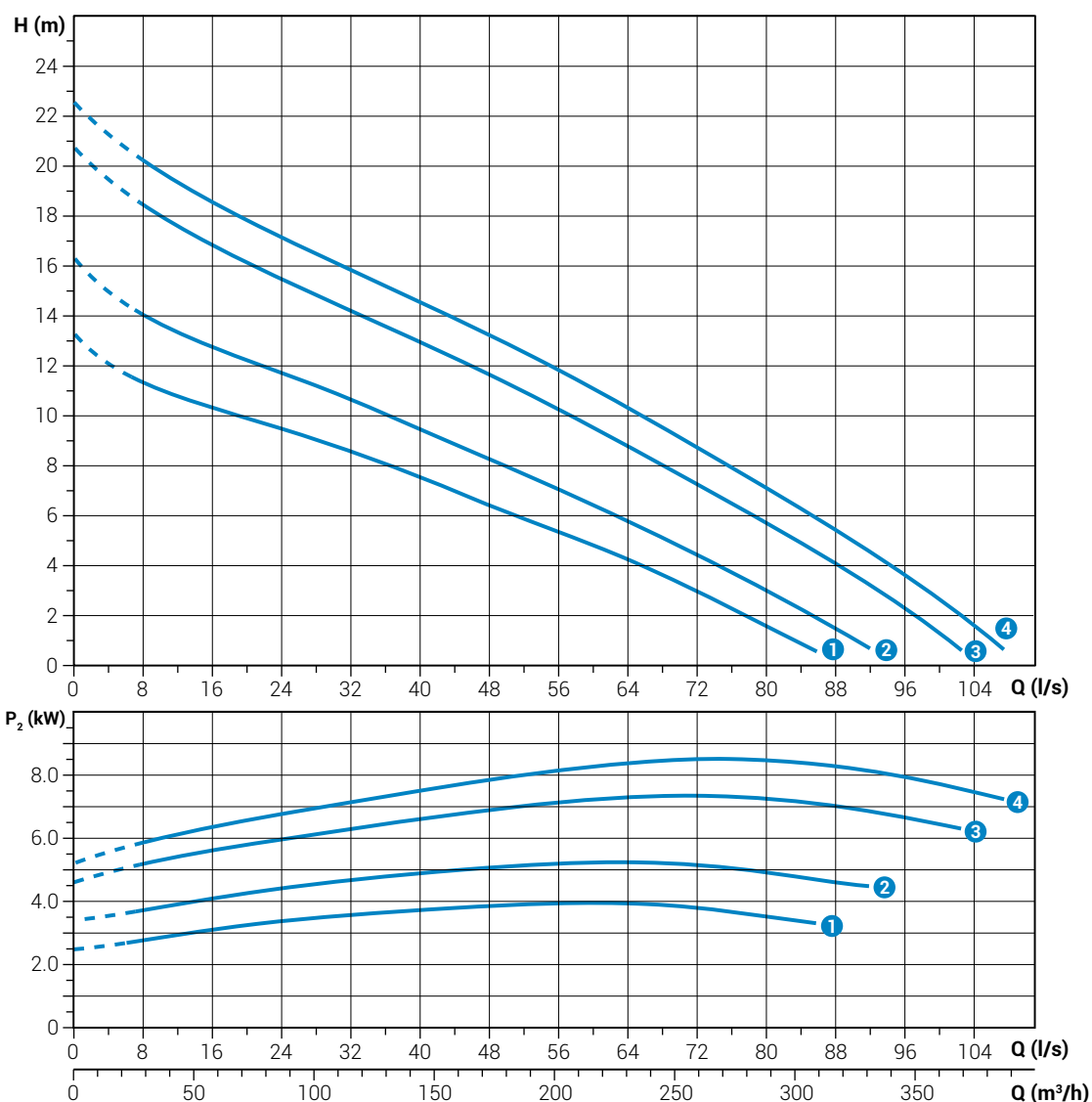
**Technical data**

	V	Phases	P1 (kw)	P2 (kw)	A	Rpm	Start	Cable	Ø	Free passage
① DRG 550/4/150 NOFT5	400	3	4.62	4.0	8.4	1450	Dir	4G1.5+3x1	DN150	65x60
② DRG 750/4/150 NOFT5	400	3	6.38	5.5	11.8	1450	Dir	4G1.5+3x1	DN150	65x60
③ DRG 1000/4/150 NOGT5	400	3	8.72	7.5	15.8	1450	Y Δ	7G1.5+3x1	DN150	65x60
④ DRG 1200/4/150 NOHT5	400	3	10.2	9.0	17.0	1450	Y Δ	7G1.5+3x1	DN150	65x60

DRG 1200-1500-2000/4/150

Performances

	l/s	0	12	24	36	48	60	72	84	96	108.0	120.0	132.0
	l/min	0	720	1440	2160	2880	3600	4320	5040	5760	6480	7200	7920
	m ³ /h	0	43.2	86.4	129.6	172.8	216	259.2	302.4	345.6	388.8	432	475.2
① DRG 1200/4/150 A0HT5		13.0	12.6	11.9	10.9	9.9	8.6	7.3	5.9	4.5	2.9	1.3	
② DRG 1500/4/150 A0HT5		17.1	16.4	15.5	14.3	12.8	11.2	9.5	7.8	6.1	4.4	2.5	
③ DRG 2000/4/150 A0HT5		26.1	23.5	21.4	19.6	18.0	16.6	14.6	12.7	10.5	8.2	5.8	3.4

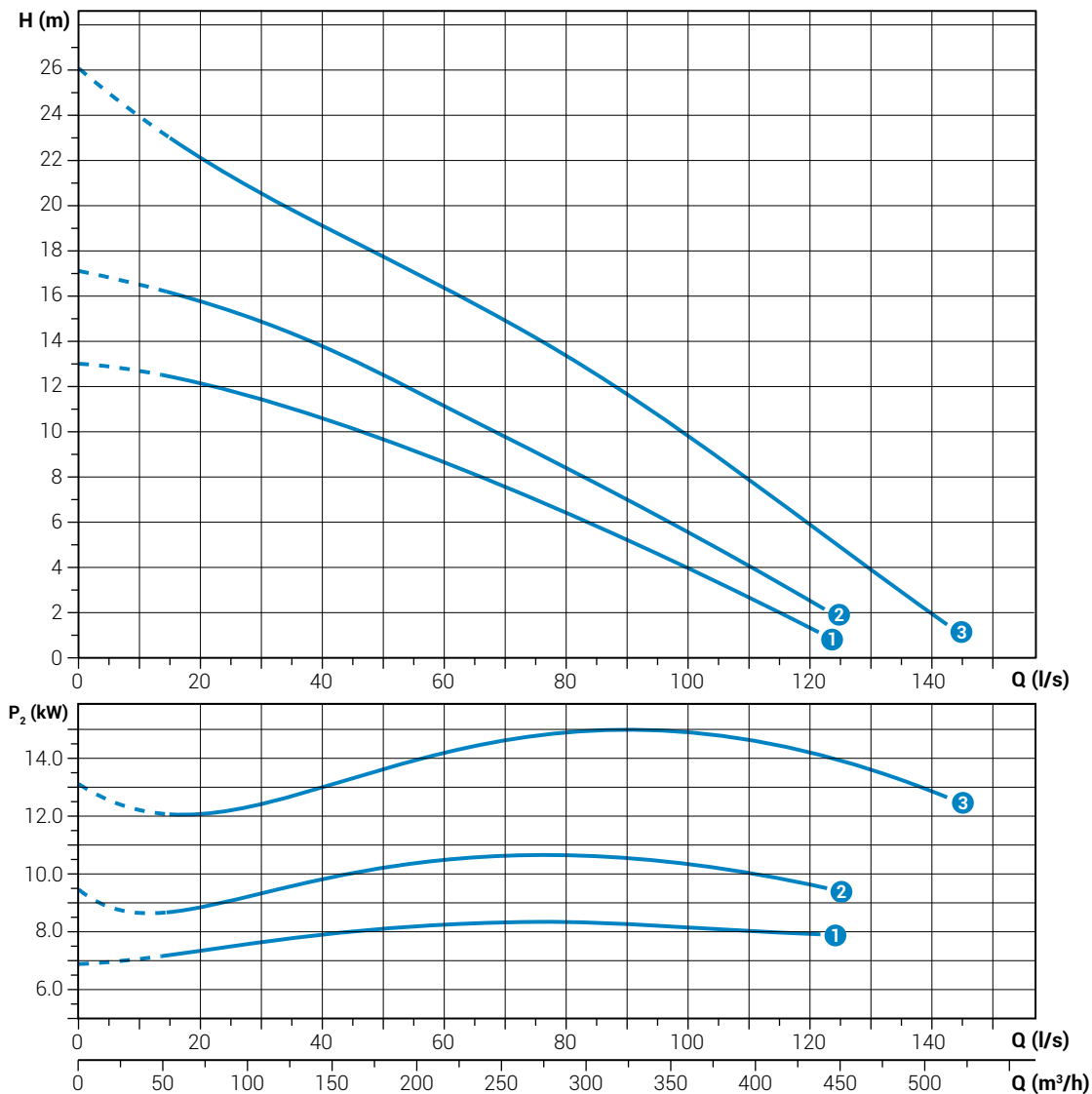

Characteristic curves according to UNI EN ISO 9906

Technical data

	V	Phases	P1 (kw)	P2 (kw)	A	Rpm	Start	Cable	Ø	Free passage
① DRG 1200/4/150 A0HT5	400	3	10.2	9.0	17	1450	Y Δ	7G1.5+3x1	DN150	80 mm
② DRG 1500/4/150 A0HT5	400	3	12.6	11.0	20.5	1450	Y Δ	7G1.5+3x1	DN150	80 mm
③ DRG 2000/4/150 A0HT5	400	3	16.7	15.0	30.8	1450	Y Δ	7G2.5+3x1	DN150	80 mm

DRG 1200-1500-2000/4/200

Performances

	l/s	0	16	32	48	64	80	96	112.0	128.0	144.0	160.0
	l/min	0	960	1920	2880	3840	4800	5760	6720	7680	8640	9600
	m ³ /h	0	57.6	115.2	172.8	230.4	288	345.6	403.2	460.8	518.4	576
① DRG 1200/4/200 B0HT5		11.9	11.2	10.3	9.2	8.1	7.0	6.0	5.0	4.0	2.8	1.2
② DRG 1500/4/200 B0HT5		13.9	13.3	12.1	10.9	9.7	8.6	7.6	6.5	5.2	3.8	2.4
③ DRG 2000/4/200 B0HT5		18.1	17.6	16.4	15.0	13.6	12.2	10.8	9.3	7.7	6.1	4.5

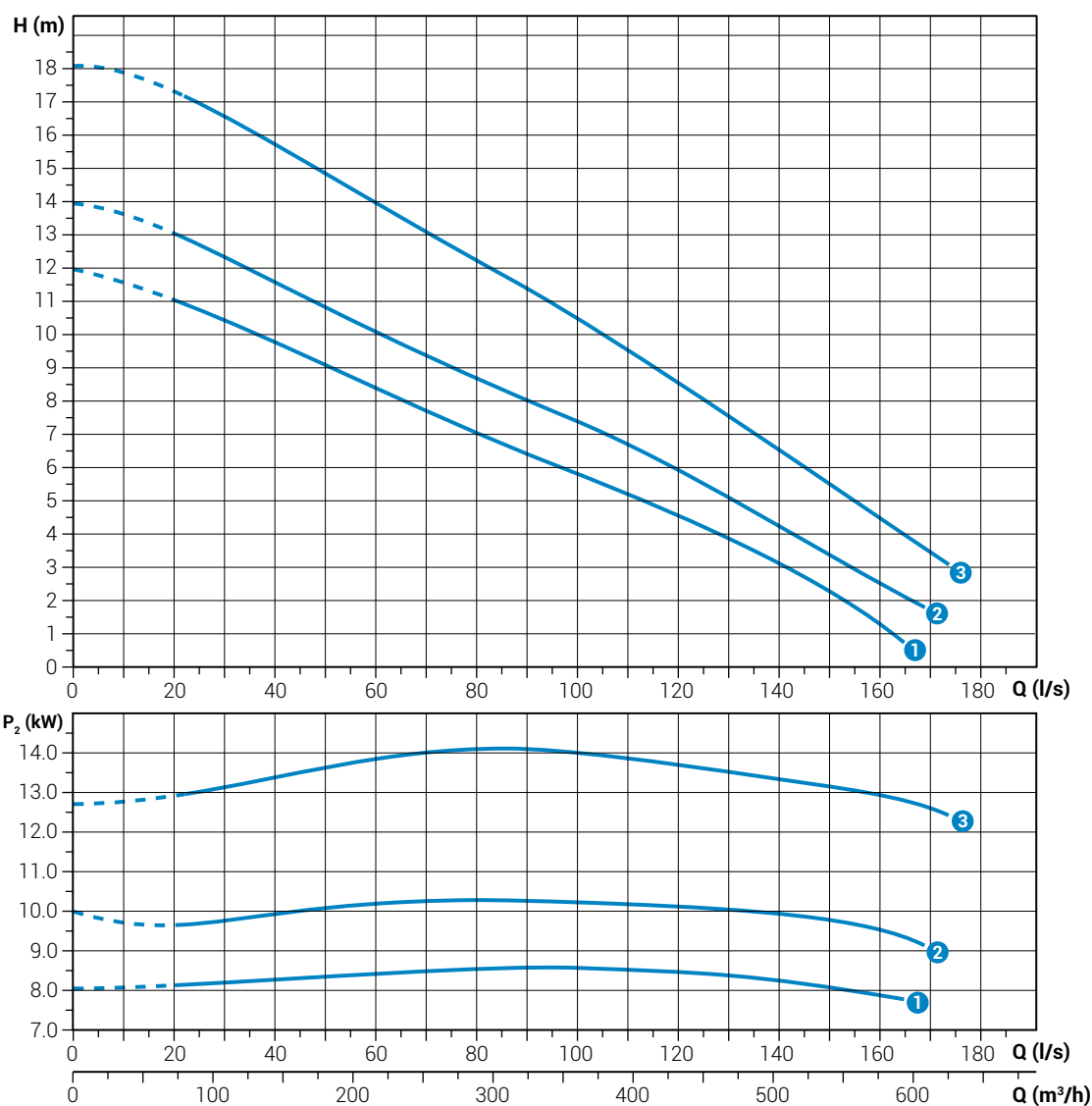

Technical data

	V	Phases	P1 (kw)	P2 (kw)	A	Rpm	Start	Cable	Ø	Free passage
① DRG 1200/4/200 B0HT5	400	3	10.2	9.0	17.0	1450	Y Δ	7G1.5+3x1	DN200	80 mm
② DRG 1500/4/200 B0HT5	400	3	12.6	11.0	20.5	1450	Y Δ	7G1.5+3x1	DN200	80 mm
③ DRG 2000/4/200 B0HT5	400	3	16.7	15.0	30.8	1450	Y Δ	7G2.5+3x1	DN200	80 mm

DRG 1200-1500-2000/4/250

Performances

	l/s	0	16	32	48	64	80	96	112.0	128.0	144.0	160.0	176.0	192.0
	l/min	0	960	1920	2880	3840	4800	5760	6720	7680	8640	9600	10560	11520
	m ³ /h	0	57.6	115.2	172.8	230.4	288	345.6	403.2	460.8	518.4	576	633.6	691.2
①	DRG 1200/4/250 H0HT5	11.3	10.8	9.9	9.0	8.0	7.2	6.4	5.6	4.7	3.6	2.4	1.3	
②	DRG 1500/4/250 H0HT5	13.3	12.7	11.7	10.7	9.7	8.7	7.8	6.9	5.8	4.7	3.4	2.1	
③	DRG 2000/4/250 H0HT5	18.1	16.9	15.7	14.5	13.3	12.2	11	9.8	8.6	7.2	5.7	4.1	2.5

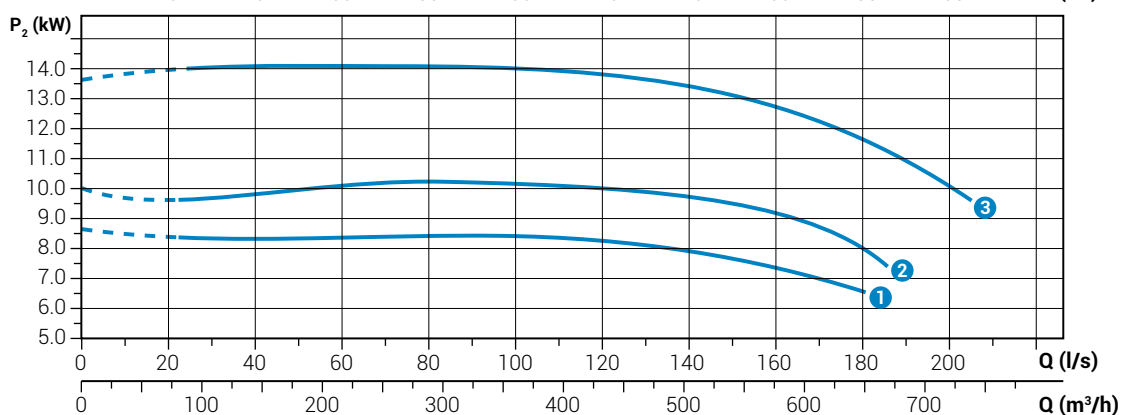
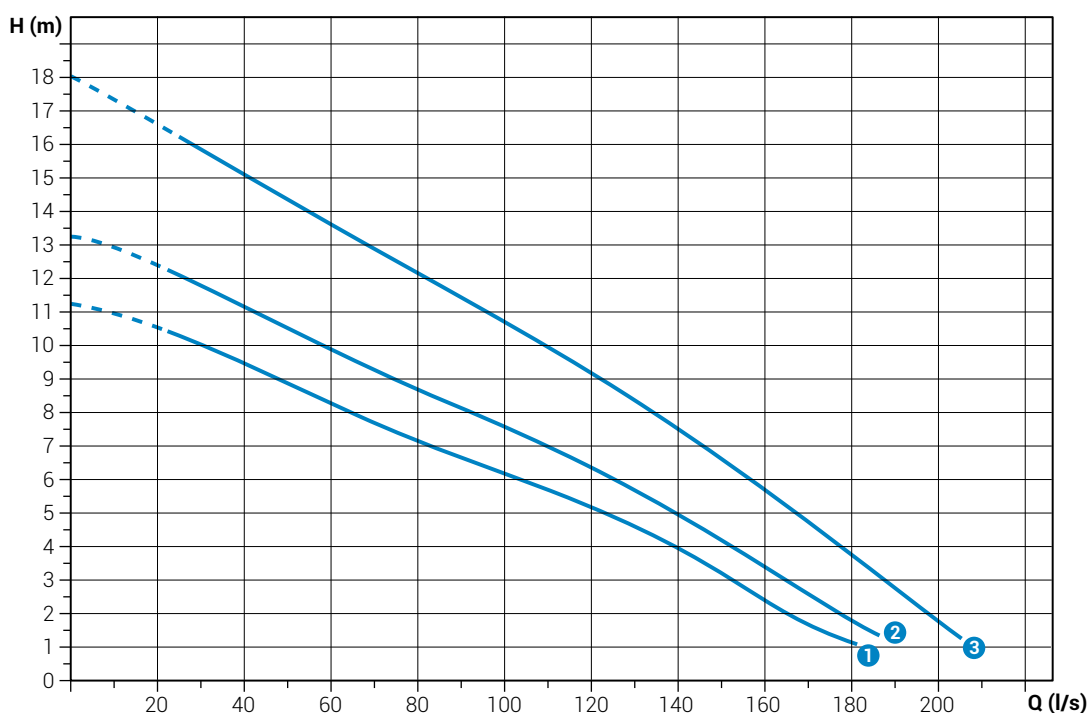

Characteristic curves according to UNI EN ISO 9906

Technical data

	V	Phases	P1 (kW)	P2 (kW)	A	Rpm	Start	Cable	Ø	Free passage	
①	DRG 1200/4/250 H0HT5	400	3	10.2	9.0	17.0	1450	Y Δ	7G1.5+3x1	DN250	80 mm
②	DRG 1500/4/250 H0HT5	400	3	12.6	11.0	20.5	1450	Y Δ	7G1.5+3x1	DN250	80 mm
③	DRG 2000/4/250 H0HT5	400	3	16.7	15.0	30.8	1450	Y Δ	7G2.5+3x1	DN250	80 mm

DRG 550-750-1000/6/150

Performances

	l/s	0	12	24	36	48	60	72	84	96	108.0	120.0
	l/min	0	720	1440	2160	2880	3600	4320	5040	5760	6480	7200
	m ³ /h	0	43.2	86.4	129.6	172.8	216	259.2	302.4	345.6	388.8	432
① DRG 550/6/150 F0GT5		7.9	7.2	6.8	6.1	5.3	4.5	3.7	2.6	1.4		
② DRG 750/6/150 F0GT5		11.9	10.6	9.4	8.5	7.7	6.8	5.7	4.4	3.1	1.4	
③ DRG 1000/6/150 F0HT5		14.8	13.2	12.0	11.0	10.1	9.1	8.0	6.7	5.3	3.9	2.5

Characteristic curves according to UNI EN ISO 9906

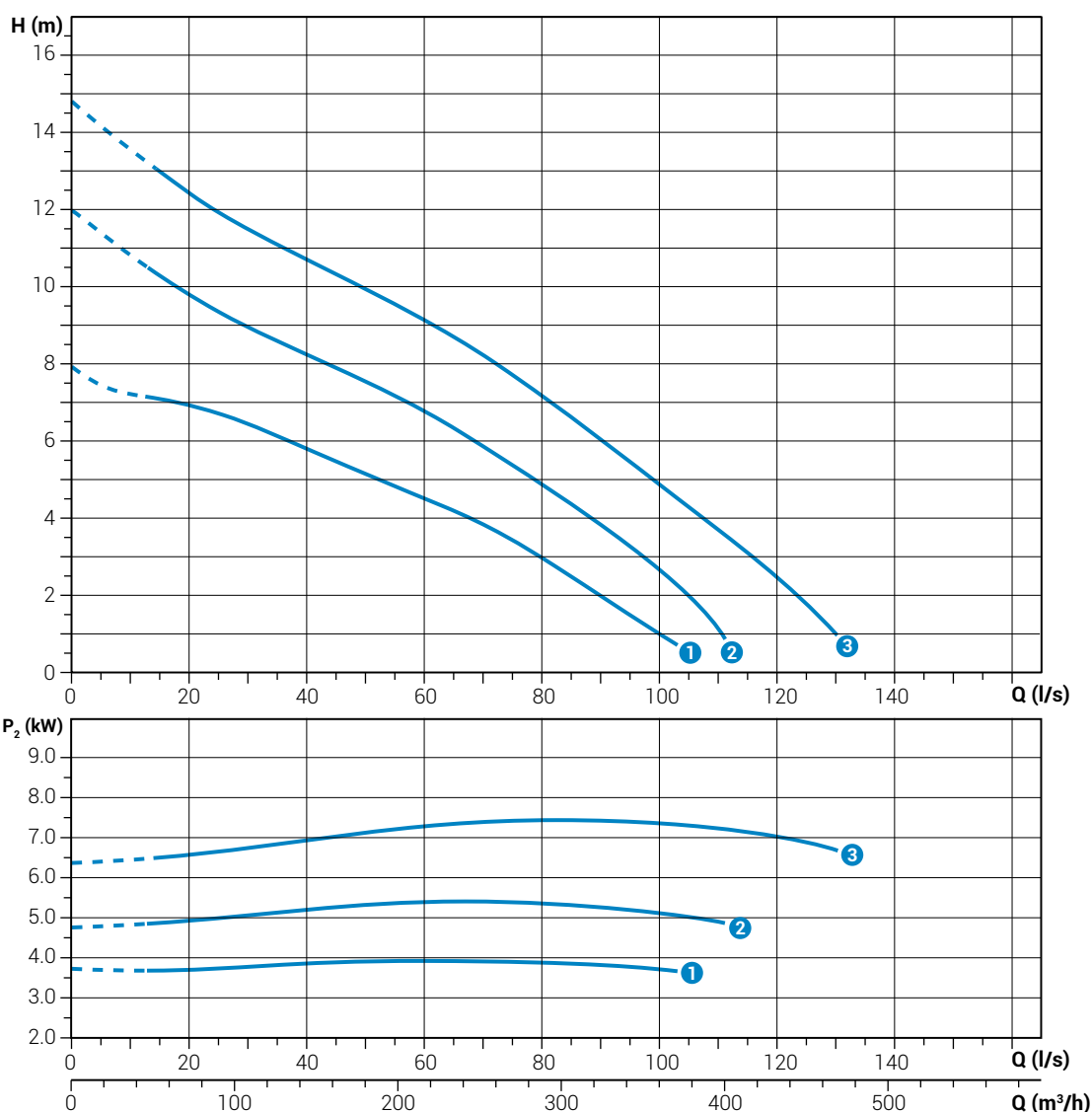

Technical data

	V	Phases	P1 (kW)	P2 (kW)	A	Rpm	Start	Cable	Ø	Free passage
① DRG 550/6/150 F0GT5	400	3	4.91	4.0	9.31	960	Y Δ	7G1.5+3x1	DN150	80 mm
② DRG 750/6/150 F0GT5	400	3	6.62	5.5	12.8	960	Y Δ	7G1.5+3x1	DN150	80 mm
③ DRG 1000/6/150 F0HT5	400	3	8.85	7.5	15.7	960	Y Δ	7G1.5+3x1	DN150	80 mm

DRG 1000-1750/6/200

Performances

	l/s	0	16	32	48	64	80	96	112.0	128.0	144.0	160.0
	l/min	0	960	1920	2880	3840	4800	5760	6720	7680	8640	9600
	m ³ /h	0	57.6	115.2	172.8	230.4	288	345.6	403.2	460.8	518.4	576
①	DRG 1000/6/200 A0HT5	12.2	10.9	10.1	9.0	7.7	6.4	5.1	3.9	2.5		
②	DRG 1000/6/200 B0HT5	14.4	12.4	10.9	9.7	8.4	7.0	5.6	4.3	2.6		
③	DRG 1750/6/200 A0HT5	17.2	16.1	14.9	13.8	12.5	11.2	9.8	8.4	6.9	5.2	3.4

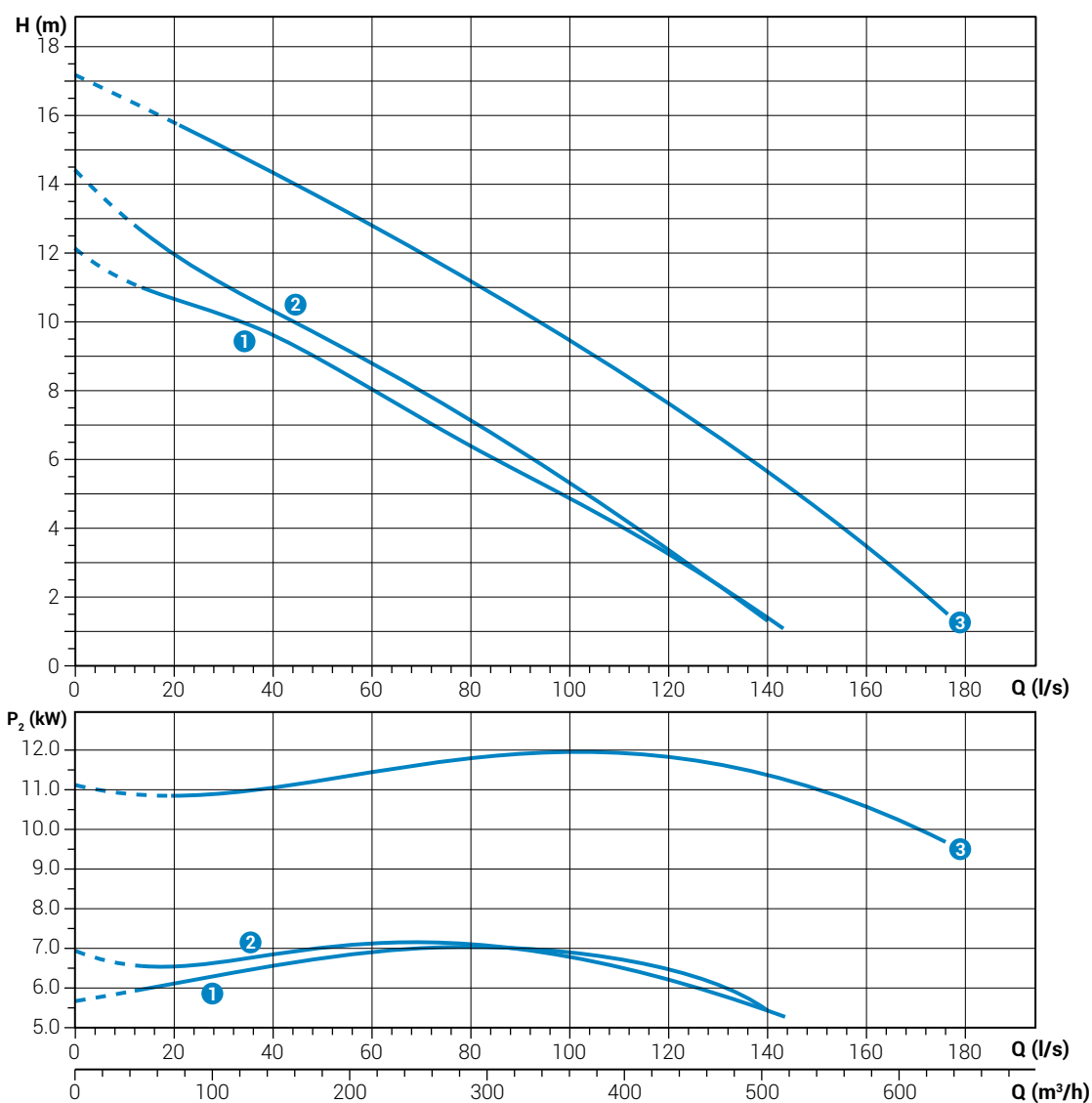

Characteristic curves according to UNI EN ISO 9906

Technical data

	V	Phases	P1 (kw)	P2 (kw)	A	Rpm	Start	Cable	Ø	Free passage	
①	DRG 1000/6/200 A0HT5	400	3	8.85	7.5	15.7	960	Y Δ	7G1.5+3x1	DN200	100x70 mm
②	DRG 1000/6/200 B0HT5	400	3	8.85	7.5	15.7	960	Y Δ	7G1.5+3x1	DN200	80 mm
③	DRG 1750/6/200 A0HT5	400	3	15.0	13.0	27.6	960	Y Δ	7G2.5+3x1	DN200	100x70 mm

DRG 1000-1750/6/250**Performances**

	l/s	0	16	32	48	64	80	96	112.0	128.0	144.0	160.0	176.0	192.0
	l/min	0	960	1920	2880	3840	4800	5760	6720	7680	8640	9600	10560	11520
	m ³ /h	0	57.6	115.2	172.8	230.4	288	345.6	403.2	460.8	518.4	576	633.6	691.2
① DRG 1000/6/250 C0HT5		11.5	10.5	9.7	8.9	7.8	6.6	5.5	4.5	3.4	2.1			
② DRG 1000/6/250 H0HT5		13.6	11.6	10.3	9.3	8.3	7.3	6.0	4.7	3.4	2.0			
③ DRG 1750/6/250 C0HT5		16.5	15.4	14.4	13.3	12.2	11.1	10.0	8.8	7.5	6.1	4.6	3.1	1.4

Characteristic curves according to UNI EN ISO 9906

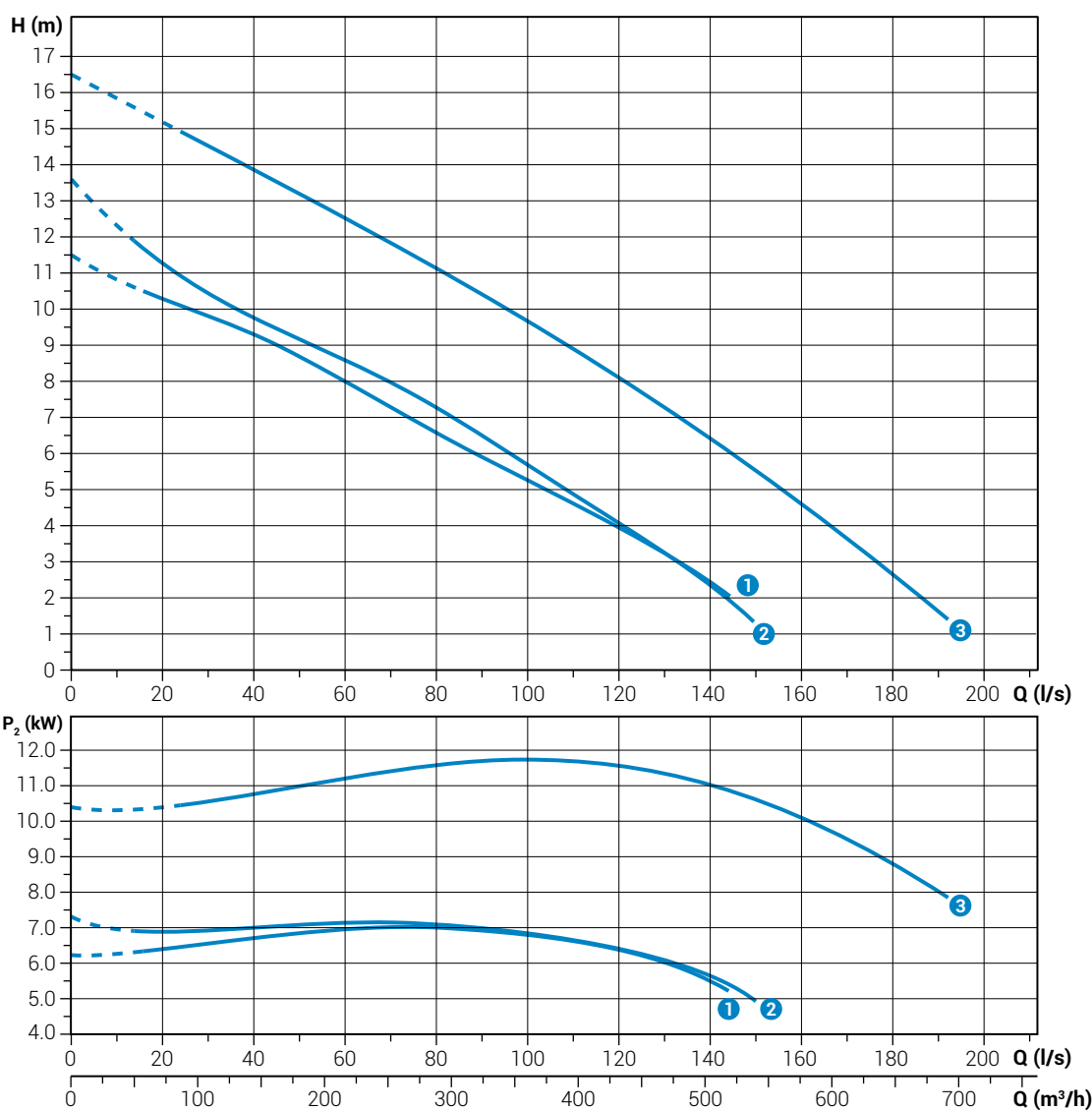
**Technical data**

	V	Phases	P1 (kw)	P2 (kw)	A	Rpm	Start	Cable	Ø	Free passage
① DRG 1000/6/250 C0HT5	400	3	8.85	7.5	15.7	960	Dir	7G1.5+3x1	DN250	100x70 mm
② DRG 1000/6/250 H0HT5	400	3	8.85	7.5	15.7	960	Dir	7G1.5+3x1	DN250	80 mm
③ DRG 1750/6/250 C0HT5	400	3	15.0	13.0	27.6	960	Dir	7G2.5+3x1	DN250	100x70 mm

DRG

Overall dimensions and weights

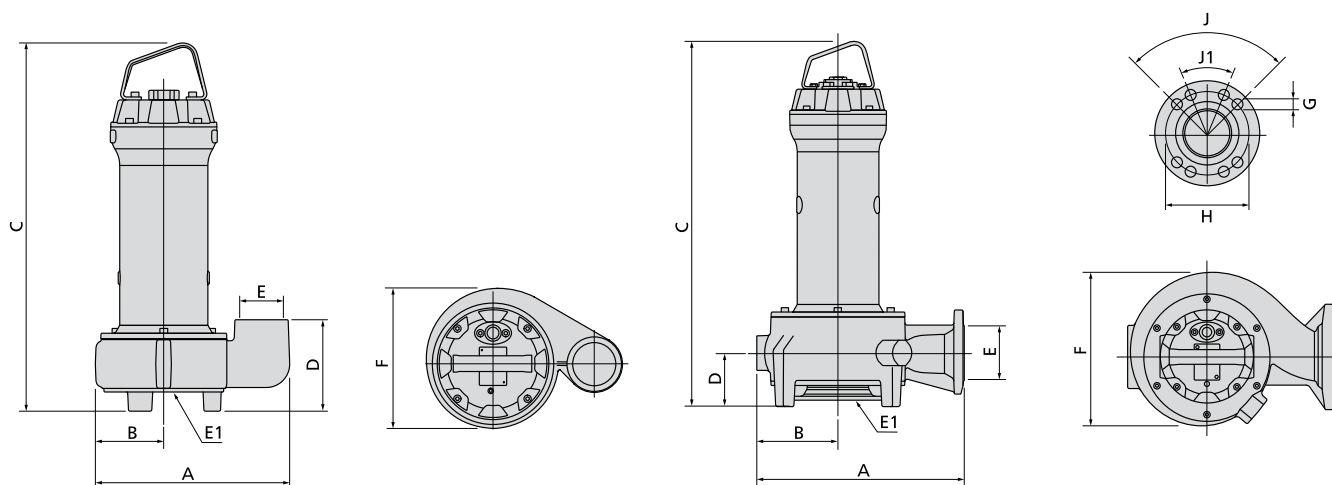

	A	B	C	D	E	E1	F	kg
DRG 250/2/G65V B0AT5	327	116	541	153	2½"	65	240	33.0
DRG 300/2/G65V A0ET5	327	116	565	153	2½"	65	240	42.2
DRG 400/2/G65V A0ET5	327	116	615	153	2½"	65	240	45.0

	A	B	C	D	E	E1	F	G	H	J°	J1°	kg
DRG 150/2/65 B0AT5	344	136	543	80	65	65	255	18	145	90	-	33.5
DRG 200/2/65 B0AT5	344	136	543	80	65	65	255	18	145	90	-	34.0
DRG 250/2/65 B0AT5	344	136	543	80	65	65	255	18	145	90	-	34.0
DRG 300/2/65 A0ET5	344	136	565	80	65	65	255	18	145	90	-	59.6
DRG 400/2/65 A0ET5	344	136	615	80	65	65	255	18	145	90	-	61.6
DRG 550/2/65 C0FT5	343	136	698	88	65	65	253	18	145	90	-	63.6
DRG 250/2/80 L0AT5	347	135	542	80	80	80	252	18	160	90	45	36.0
DRG 300/2/80 E0ET5	347	135	564	80	80	80	252	18	160	90	45	60.6
DRG 400/2/80 E0ET5	347	135	614	80	80	80	252	18	160	90	45	62.6
DRG 550/2/80 B0FT5	327	142	707	91	80	80	271	18	160	90	45	68.0
DRG 550/2/80 P0FT5	343	136	698	88	80	80	253	18	160	90	45	63.6
DRG 750/2/80 A0FT5	327	142	707	91	80	80	271	18	160	90	45	70.7
DRG 750/2/80 B0FT5	327	142	707	91	80	80	271	18	160	90	45	70.7
DRG 1000/2/80 A0FT5	327	142	782	91	80	80	271	18	160	90	45	79.7
DRG 1000/2/80 B0FT5	327	142	782	91	80	80	271	18	160	90	45	79.7
DRG 1200/2/80 A0GT5	327	142	850	91	80	80	271	18	160	90	45	110.0
DRG 1200/2/80 B0GT5	327	142	850	91	80	80	271	18	160	90	45	110.0
DRG 1500/2/80 A0GT5	327	142	850	91	80	80	271	18	160	90	45	113.0
DRG 1500/2/80 B0GT5	327	142	850	91	80	80	271	18	160	90	45	113.0
DRG 2000/2/80 G0HT5	393	151	930	88	80	80	293	18	160	90	45	155.0
DRG 2000/2/80 W0HT5	481	188	980	124	80	150	360	18	160	90	45	183.0
DRG 2500/2/80 G0HT5	393	151	1033	88	80	80	293	18	160	90	45	165.0
DRG 2500/2/80 W0HT5	481	188	1070	124	80	150	360	18	160	90	45	193.0
DRG 200/4/80 M0ET5	394	151	603	88	80	80	292	18	160	90	45	66.0
DRG 300/4/80 G0ET5	393	151	653	88	80	80	292	18	160	90	45	72.6
DRG 400/4/80 H0ET5	393	151	653	88	80	80	291	18	160	90	45	77.0
DRG 550/4/80 D0FT5	481	188	831	124	80	150	367	18	160	90	45	108.8
DRG 750/4/80 D0FT5	481	188	831	124	80	150	367	18	160	90	45	109.8
DRG 1000/4/80 D0GT5	481	188	899	124	80	150	367	18	160	90	45	141.0
DRG 1200/4/80 D0HT5	481	188	980	124	80	150	367	18	160	90	45	199.0

Dimensions in mm

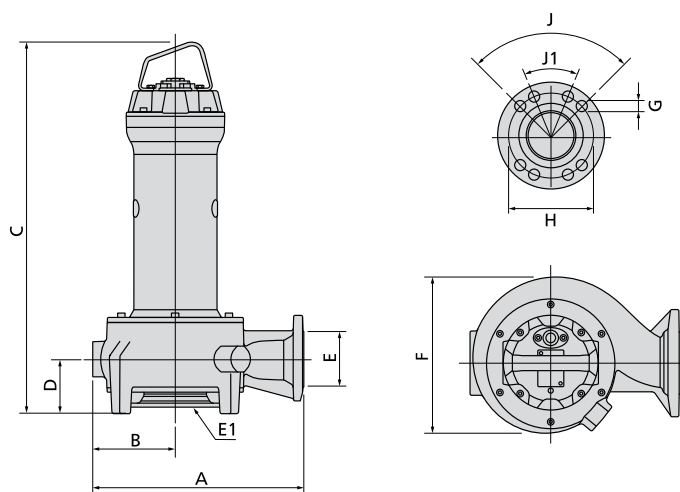

	A	B	C	D	E	E1	F	G	H	J°	J1°	kg
DRG 200/4/100 T0ET5	417	160	603	91	100	100	310	18	180	45	-	69.0
DRG 300/4/100 U0ET5	417	160	653	91	100	100	310	18	180	45	-	75.6
DRG 300/4/100 X0ET5	417	160	653	91	100	100	310	18	180	45	-	63.2
DRG 400/4/100 U0ET5	417	160	653	91	100	100	310	18	180	45	-	80.0
DRG 400/4/100 Y0ET5	417	160	653	91	100	100	310	18	180	45	-	64.8
DRG 550/4/100 R0FT5	449	183	780	91	100	100	353	18	180	45	-	88.8
DRG 750/4/100 L0FT5	552	212	832	124	100	150	400	18	180	45	-	112.2
DRG 1000/4/100 L0GT5	552	212	900	124	100	150	400	18	180	45	-	143.0
DRG 1200/4/100 H0HT5	548	208	979	124	100	150	413	18	180	45	-	211.0
DRG 1200/4/100 L0HT5	552	212	980	124	100	150	400	18	180	45	-	185.0
DRG 1500/4/100 A0HT5	548	208	979	124	100	100	413	18	180	45	-	222.0
DRG 2000/4/100 A0HT5	548	208	1069	124	100	100	413	18	180	45	-	227.1
DRG 2000/4/100 B0HT5	590	240	1072	121	100	100	471	18	180	45	-	228.1
DRG 550/4/150 N0FT5	616	227	838	130	150	150	449	24	240	45	-	120.0
DRG 750/4/150 N0FT5	616	227	838	130	150	150	449	24	240	45	-	120.2
DRG 1000/4/150 N0GT5	616	227	905	130	150	150	449	24	240	45	-	151.0
DRG 1200/4/150 A0HT5	612	222	985	130	150	150	447	24	240	45	-	228.1
DRG 1200/4/150 N0HT5	616	227	985	130	150	150	449	24	240	45	-	193.0
DRG 1500/4/150 A0HT5	612	222	985	130	150	150	447	24	240	45	-	234.0
DRG 2000/4/150 A0HT5	612	222	1075	130	150	150	447	24	240	45	-	240.0
DRG 1200/4/200 B0HT5	692	273	1046	172	200	200	539	24	295	45	-	255.0
DRG 1500/4/200 B0HT5	692	273	1136	172	200	200	539	24	295	45	-	261.0
DRG 2000/4/200 B0HT5	692	273	1136	172	200	200	539	24	295	45	-	267.0
DRG 1200/4/250 H0HT5	808	334	1046	203	250	200	609	24	350	30	-	286.0
DRG 1500/4/250 H0HT5	808	334	1136	203	250	200	609	24	350	30	-	292.0
DRG 2000/4/250 H0HT5	808	334	1136	203	250	200	609	24	350	30	-	298.0
DRG 550/6/150 F0GT5	647	252	1015	172	150	200	507	24	350	30	-	193.0
DRG 750/6/150 F0GT5	647	252	1015	172	150	200	507	24	350	30	-	195.0
DRG 1000/6/150 F0HT5	647	252	1047	172	150	200	507	24	350	30	-	235.0
DRG 1000/6/200 A0HT5	692	273	1077	203	200	250	539	24	295	45	-	298.8
DRG 1000/6/200 B0HT5	692	273	1046	172	200	200	539	24	295	45	-	261.0
DRG 1750/6/200 A0HT5	692	273	1167	203	200	250	539	24	295	45	-	308.8
DRG 1000/6/250 C0HT5	808	334	1078	203	250	250	609	24	350	30	-	324.3
DRG 1000/6/250 H0HT5	808	334	1046	203	250	200	609	24	350	30	-	292.0
DRG 1750/6/250 C0HT5	808	334	1168	203	250	250	609	24	350	30	-	334.3

Dimensions in mm

DRG

Packaging dimension



	X	Y	Z
DRG 250/2/G65V B0AT5	445	725	425
DRG 300/2/G65V A0ET5	445	725	425
DRG 400/2/G65V A0ET5	445	725	425
DRG 150/2/65 B0AT5	445	725	425
DRG 200/2/65 B0AT5	445	725	425
DRG 250/2/65 B0AT5	445	725	425
DRG 300/2/65 A0ET5	445	725	425
DRG 400/2/65 A0ET5	445	725	425
DRG 550/2/65 C0FT5	445	725	425
DRG 250/2/80 L0AT5	445	725	425
DRG 300/2/80 E0ET5	445	725	425
DRG 400/2/80 E0ET5	445	725	425
DRG 550/2/80 B0FT5	445	725	425
DRG 550/2/80 P0FT5	445	725	425
DRG 750/2/80 A0FT5	445	725	425
DRG 750/2/80 B0FT5	445	725	425
DRG 1000/2/80 A0FT5	535	915	560
DRG 1000/2/80 B0FT5	535	915	560
DRG 1200/2/80 A0GT5	535	915	560
DRG 1200/2/80 B0GT5	535	915	560
DRG 1500/2/80 A0GT5	535	915	560
DRG 1500/2/80 B0GT5	535	915	560
DRG 2000/2/80 G0HT5	535	1000	560
DRG 2000/2/80 W0HT5	535	915	560
DRG 2500/2/80 G0HT5	725	1270	675
DRG 2500/2/80 W0HT5	725	1270	675
DRG 1200/2/100 K0GT5	535	915	560
DRG 1500/2/100 K0GT5	535	915	560
DRG 200/4/80 M0ET5	445	725	425
DRG 300/4/80 G0ET5	445	725	425
DRG 400/4/80 H0ET5	445	725	425
DRG 550/4/80 D0FT5	535	915	560
DRG 750/4/80 D0FT5	535	915	560
DRG 1000/4/80 D0GT5	535	915	560
DRG 1200/4/80 D0HT5	725	1270	675

	X	Y	Z
DRG 200/4/100 T0ET5	445	725	425
DRG 300/4/100 U0ET5	445	725	425
DRG 300/4/100 X0ET5	445	725	425
DRG 400/4/100 U0ET5	445	725	425
DRG 400/4/100 Y0ET5	445	725	425
DRG 550/4/100 R0FT5	535	915	560
DRG 750/4/100 L0FT5	725	1270	675
DRG 1000/4/100 L0GT5	725	1270	675
DRG 1200/4/100 H0HT5	725	1270	675
DRG 1200/4/100 L0HT5	725	1270	675
DRG 1500/4/100 A0HT5	725	1270	675
DRG 2000/4/100 A0HT5	725	1270	675
DRG 2000/4/100 B0HT5	725	1270	675
DRG 550/4/150 N0FT5	725	1270	675
DRG 750/4/150 N0FT5	725	1270	675
DRG 1000/4/150 N0GT5	725	1270	675
DRG 1200/4/150 A0HT5	725	1270	675
DRG 1200/4/150 N0HT5	725	1270	675
DRG 1500/4/150 A0HT5	725	1270	675
DRG 2000/4/150 A0HT5	725	1270	675
DRG 1200/4/200 B0HT5	725	1270	675
DRG 1500/4/200 B0HT5	725	1270	675
DRG 2000/4/200 B0HT5	725	1270	675
DRG 1200/4/250 H0HT5	825	1070	1355
DRG 1500/4/250 H0HT5	825	1070	1355
DRG 2000/4/250 H0HT5	825	1070	1355
DRG 550/6/150 F0GT5	725	1270	675
DRG 750/6/150 F0GT5	725	1270	675
DRG 1000/6/150 F0HT5	725	1270	675
DRG 1000/6/200 A0HT5	725	1270	675
DRG 1000/6/200 B0HT5	725	1270	675
DRG 1750/6/200 A0HT5	725	1270	675
DRG 1000/6/250 C0HT5	825	1070	1355
DRG 1000/6/250 H0HT5	825	1070	1355
DRG 1750/6/250 C0HT5	825	1070	1355

Dimensions in mm

Impeller with grinder system

Operating ranges

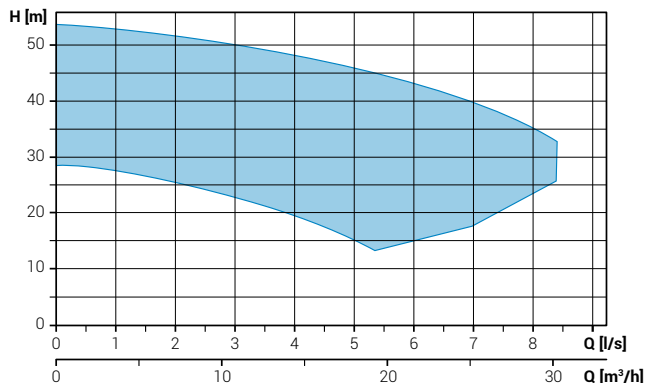

Range characteristics

Motor power	1.8 ÷ 7.5 kW
Poles	2
Insulation class	H
Degree of protection	IP68
Discharge	GAS 1½" - 2" DN32 horizontal
Free passage	-
Max flow rate	8.4 l/s
Max head	53.7 m

Motor

Ecological dry motor with thermal protections

Cable

S1RN8-F electric cable. Standard version 10 m cable length

Mechanical seals

Two silicon carbide (SiC) mechanical seals in oil sump

Applications

Designed for professional and industrial use, it is suitable for the treatment of liquids containing suspended solids or fibres.

Installations

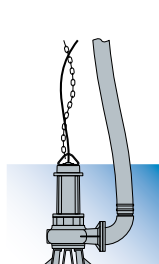

Free

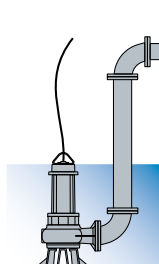

Fixed

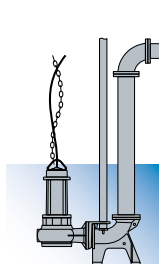

with base coupling foot

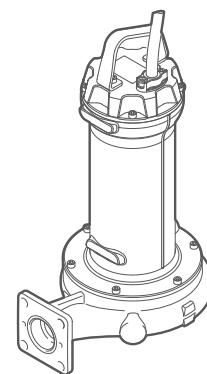
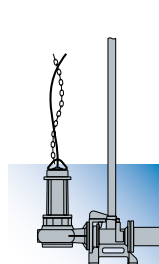

Versions

Electrical variants	NAE, TS
Cooling system	N
Mechanical seals	2SiC

Operating specifications

Max operating temperature	40 °C
PH of treated fluid	6 ÷ 14
Viscosity of treated fluid	1 mm²/s
Maximum immersion depth	20 m
Density of treated fluid	1 Kg/dm³
Acoustic pressure max	<70dB
Max starts per hour	30

Construction materials

Case	Cast iron EN-GJL 250
Hydraulic parts	Cast iron EN-GJL 250
Impeller	Cast iron EN-GJL 250
Nuts and bolts	Stainless steel - Class A2-70
Standard gasket	Rubber - NBR
Shaft	Stainless steel - AISI 431
Cutter	Chromium steel
Paint type	Ecological bicomponent epoxy (~ 200 µm)

GRG 250/2/G40H

Performances

	l/s	0	0.5	1.0	1.5	2.0	2.5	3.0	3.5	4.0	4.5	5.0
	l/min	0	30	60	90	120	150	180	210	240	270	300
	m ³ /h	0	1.8	3.6	5.4	7.2	9.0	10.8	12.6	14.4	16.2	18.0
① GRG 250/2/G40H A0AT5		28.5	28.2	27.5	26.5	25.4	24.1	22.7	21.2	19.4	17.3	14.9

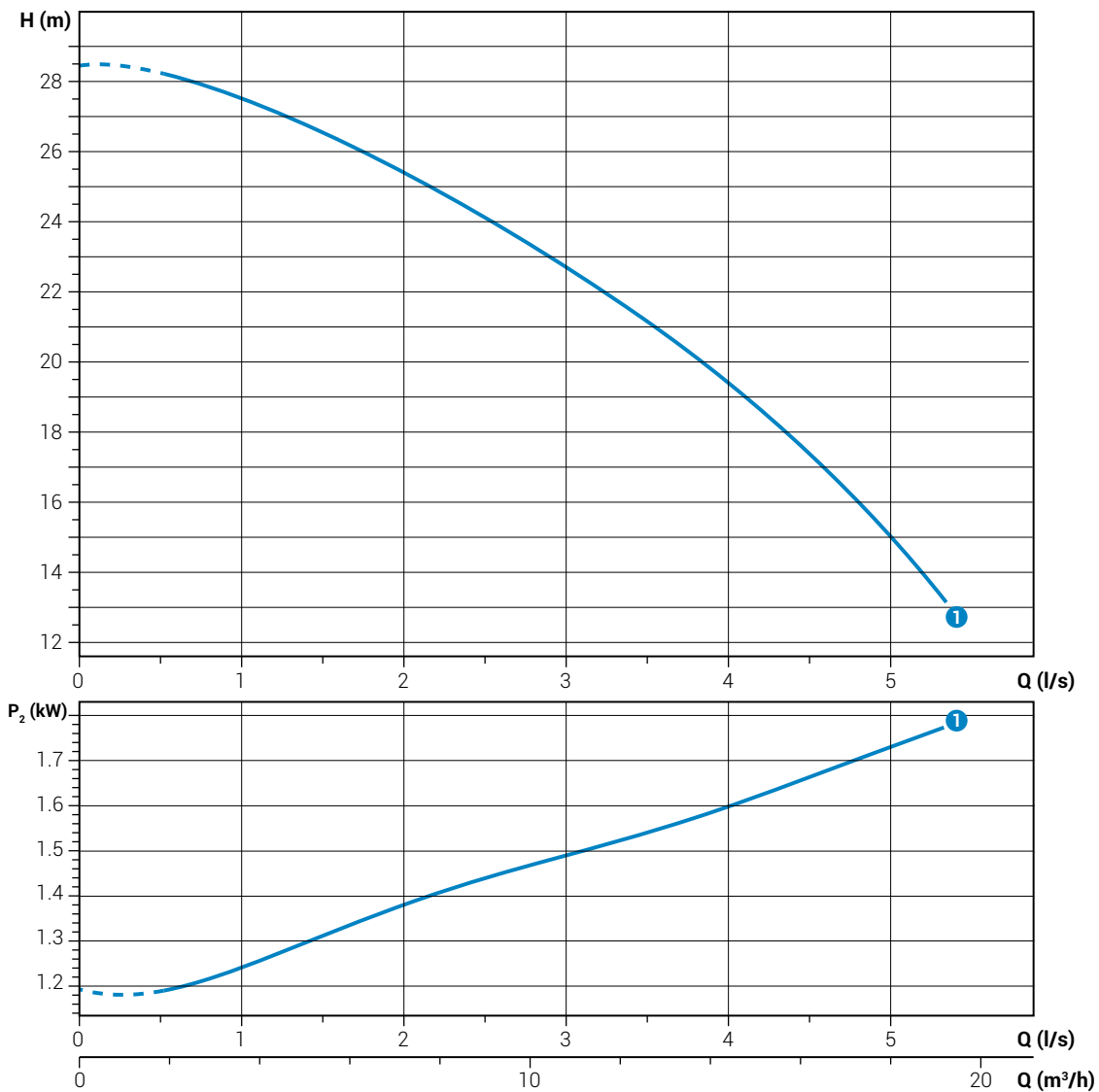

Characteristic curves according to UNI EN ISO 9906

Technical data

	V	Phases	P1 (kW)	P2 (kW)	A	Rpm	Start	Cable	Ø	Free passage
① GRG 250/2/G40H A0AT5	400	3	2.19	1.8	3.7	2900	Dir	4G1	DN32-G1½"	-

GRG 300 ÷ 1000/2/G50H

Performances

		Q								
		0	1	2	3	4	5	6	7	8
		l/s	l/min	m ³ /h	l/s	l/min	m ³ /h	l/s	l/min	m ³ /h
①	GRG 300/2/G50H C0ET5	30.3	29.3	27.9	26.1	24.0	21.6			
②	GRG 400/2/G50H D0ET5	35.8	34.8	33.0	31.1	28.5	25.3	21.8	17.7	
③	GRG 550/2/G50H D0T5	45.1	44.4	42.8	40.6	38.1	35.3			
④	GRG 750/2/G50H A0FT5	46.6	45.9	44.6	42.8	40.8	38.5	35.8	32.4	27.9
⑤	GRG 1000/2/G50H A0FT5	53.7	52.9	51.6	50.0	48.2	46.0	43.3	39.8	35.2

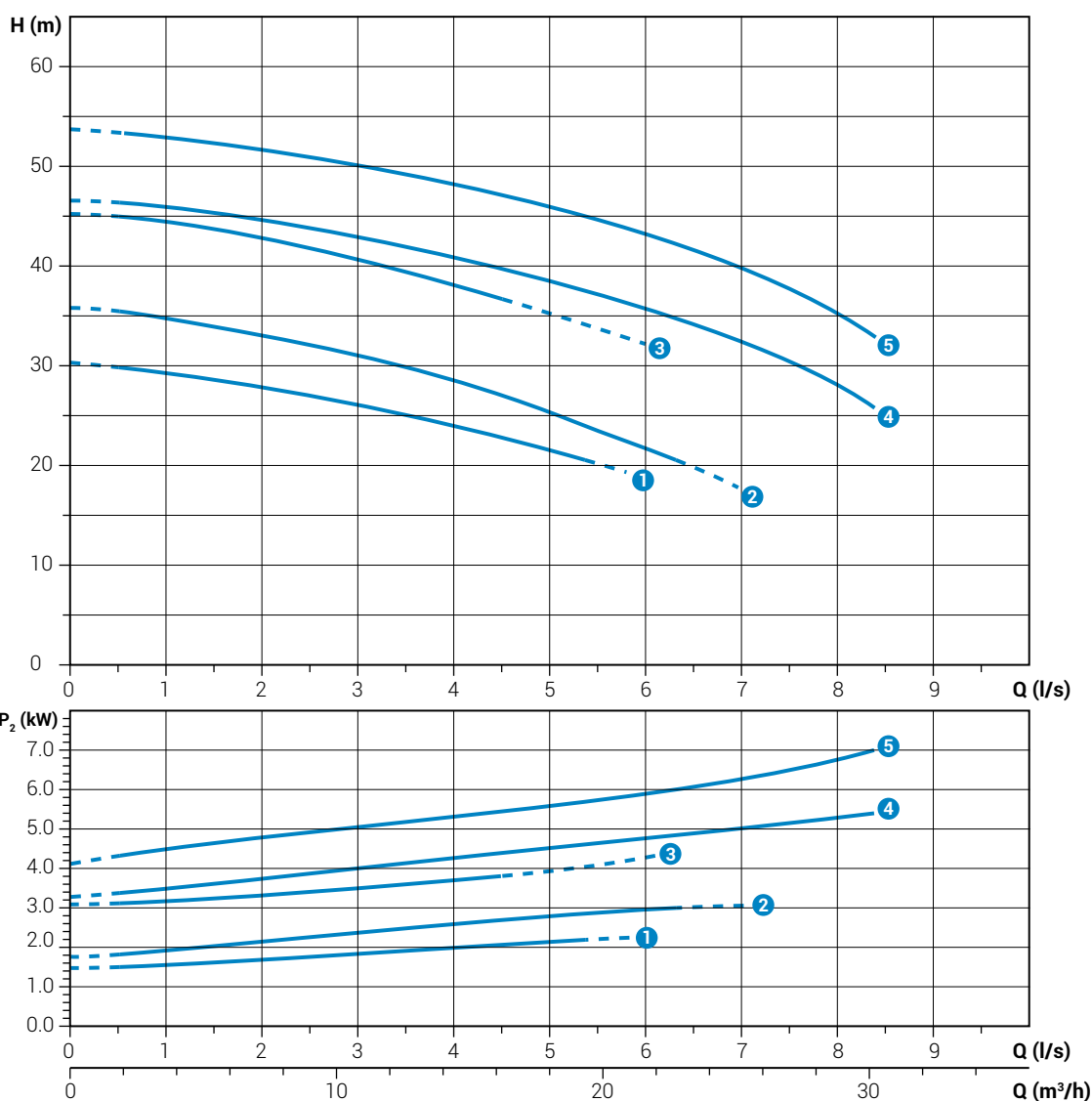

Technical data

	V	Phases	P1 (kw)	P2 (kw)	A	Rpm	Start	Cable	Ø	Free passage	
①	GRG 300/2/G50H C0ET5	400	3	2.76	2.2	4.62	2900	Dir	4G1.5+3x1	DN32-G2"	-
②	GRG 400/2/G50H D0ET5	400	3	3.68	3.0	6.36	2900	Dir	4G1.5+3x1	DN32-G2"	-
③	GRG 550/2/G50H D0T5	400	3	4.66	4.0	7.73	2900	Dir	4G1.5+3x1	DN32-G2"	-
④	GRG 750/2/G50H A0FT5	400	3	6.32	5.5	10.8	2900	Dir	4G1.5+3x1	DN32-G2"	-
⑤	GRG 1000/2/G50H A0FT5	400	3	8.51	7.5	13.7	2900	Dir	4G1.5+3x1	DN32-G2"	-

GRG

Overall dimensions and weights

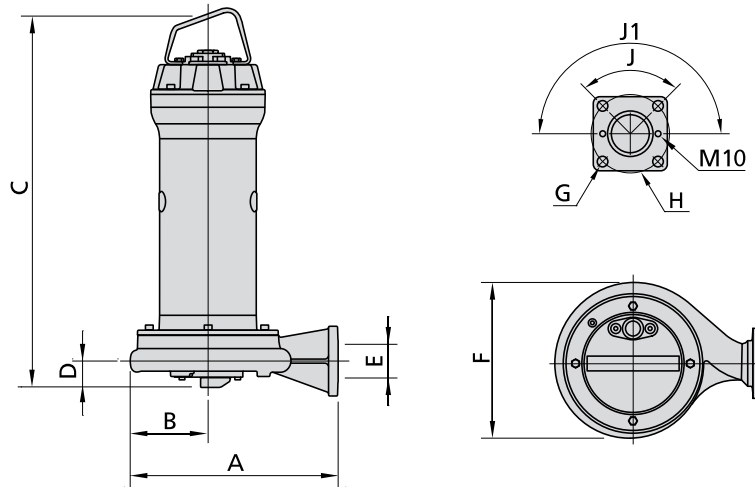

	A	B	C	D	E	F	G	H	J°	J1°	kg
GRG 250/2/G40H A0AT5	267	103	491	45	GAS 1½" - DN32	215	14	90	-	90	32.0
GRG 300/2/G50H C0ET5	305	110	527	56	GAS 2" - DN32	225	18	125	90	180	58.6
GRG 400/2/G50H D0ET5	352	132	594	59	GAS 2" - DN32	263	18	125	90	180	59.6
GRG 550/2/G50H D0T5	352	128	652	59	GAS 2" - DN32	263	18	125	90	180	57.0
GRG 750/2/G50H A0FT5	352	128	652	59	GAS 2" - DN32	263	18	125	90	180	59.7
GRG 1000/2/G50H A0FT5	352	128	727	59	GAS 2" - DN32	263	18	125	90	180	68.7

Dimensions in mm

Packaging dimension



	X	Y	Z
GRG 250/2/G40H A0AT5	310	580	310
GRG 300/2/G50H C0ET5	445	725	425
GRG 400/2/G50H D0ET5	445	725	425
GRG 550/2/G50H D0T5	445	725	425
GRG 750/2/G50H A0FT5	445	725	425
GRG 1000/2/G50H A0FT5	535	915	560

Dimensions in mm

High head impeller

Operating ranges

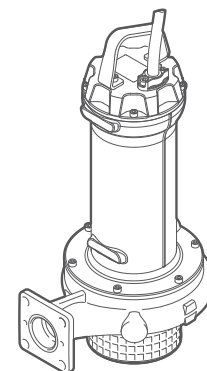
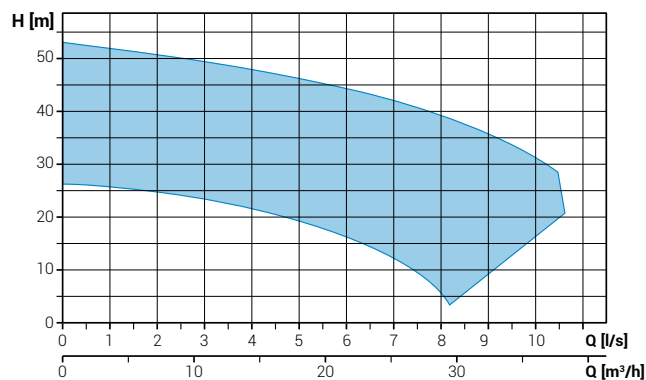

Range characteristics

Motor power	1.8 ÷ 7.5 kW
Poles	2
Insulation class	H
Degree of protection	IP68
Discharge	GAS 1 ½ - 2" DN32 horizontal
Free passage	max 10 mm
Max flow rate	10.5 l/s
Max head	53.0 m

Motor

Ecological dry motor with thermal protections.

Cable

S1RN8-F electric cable. Standard version 10 m cable length.

Mechanical seals

Two silicon carbide (SiC) mechanical seals in oil sump.

Applications

The considerable manometric head guarantees excellent results for the creation of water features and decorative fountains; suitable for use in agriculture, irrigation and the fish processing sector.

Installations

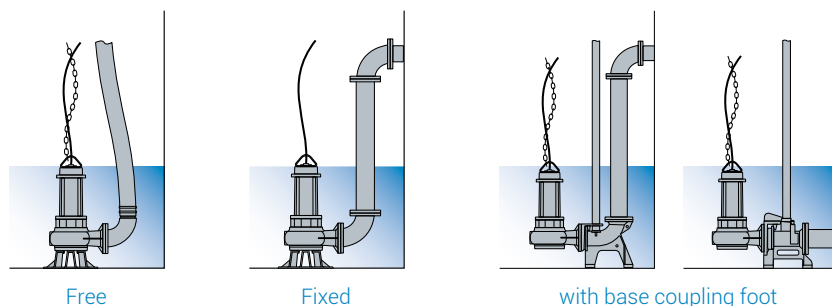

Versions

Electrical variants	NAE, TS
Cooling system	N
Mechanical seals	2SIC

Operating specifications

Max operating temperature	40 °C
PH of treated fluid	6 ÷ 14
Viscosity of treated fluid	1 mm²/s
Maximum immersion depth	20 m
Density of treated fluid	1 Kg/dm³
Acoustic pressure max	<70dB
Max starts per hour	30

Construction materials

Case	Cast iron EN-GJL 250
Hydraulic parts	Cast iron EN-GJL 250
Impeller	Cast iron EN-GJL 250
Nuts and bolts	Stainless steel - Class A2-70
Standard gasket	Rubber - NBR
Shaft	Stainless steel - AISI 431
Strainer	Stainless steel - AISI 304
Paint type	Ecological bicomponent epoxy (~ 200 µm)

APG 250/2/G40H

Performances

	0	1	2	3	4	5	6	7
l/s	0	1	2	3	4	5	6	7
l/min	0	60	120	180	240	300	360	420
m ³ /h	0	3.6	7.2	10.8	14.4	18	21.6	25.2
① APG 250/2/G40H A0AT5	26.0	25.7	24.6	23.3	21.6	19.2	16.2	12.3

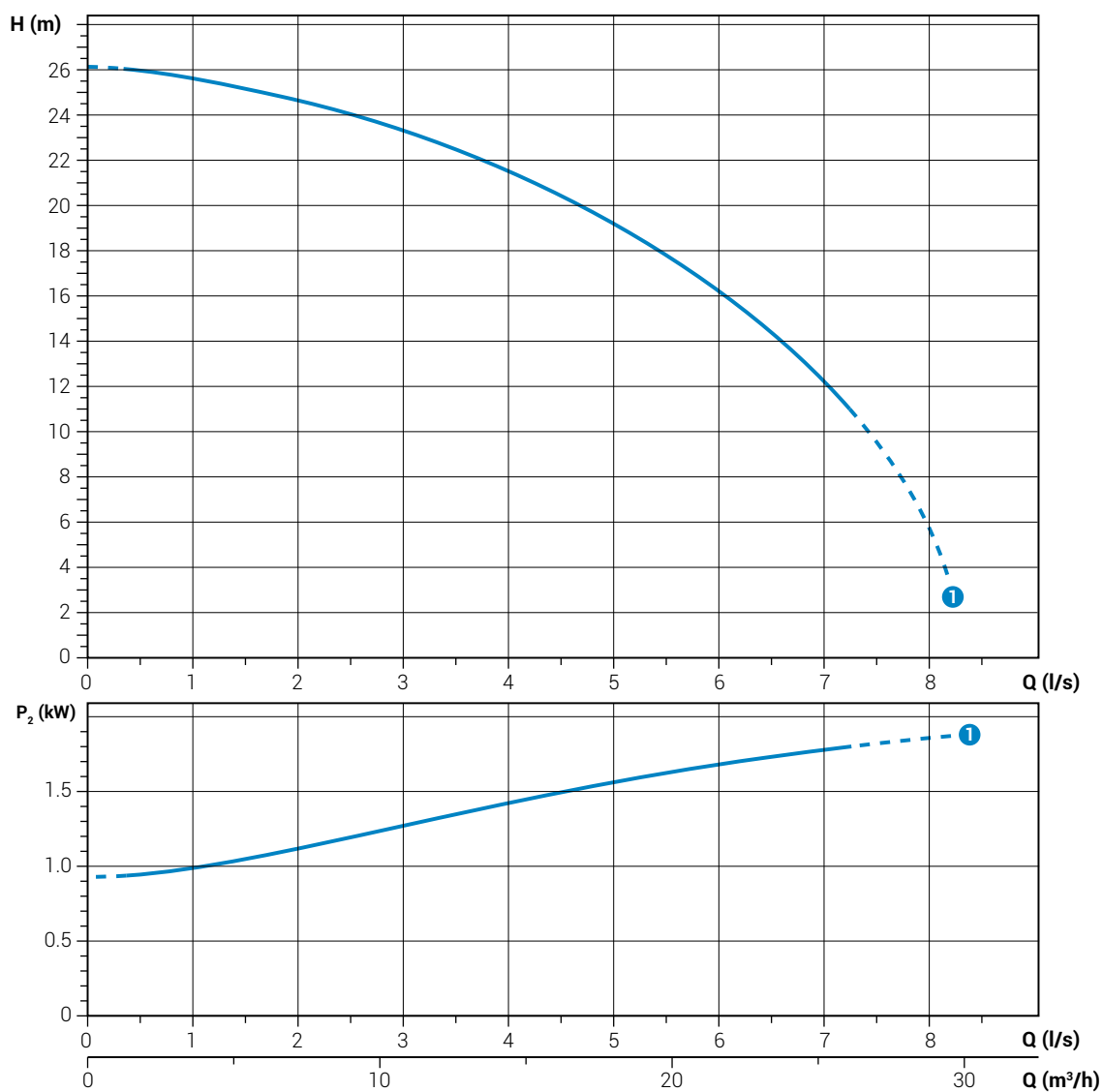

Characteristic curves according to UNI EN ISO 9906

Technical data

	V	Phases	P1 (kW)	P2 (kW)	A	Rpm	Start	Cable	Ø	Free passage
① APG 250/2/G40H A0AT5	400	3	2.19	1.8	3.7	2900	Dir	4G1	DN32-G 1½"	10 mm

APG 300 ÷ 1000/2/G50H

Performances

		Q										
		0	1	2	3	4	5	6	7	8	9	10
		l/s	l/min	m ³ /h								
①	APG 300/2/G50H C0ET5	29.2	28.2	27.0	25.6	24.1	22.5	20.4	17.6			
②	APG 400/2/G50H D0ET5	32.2	31.4	29.9	28.5	27.2	25.9	24.4				
③	APG 550/2/G50H D0FT5	38.6	37.6	36.1	34.5	32.9	31.3	29.6	27.7	25.4		
④	APG 750/2/G50H A0FT5	45.8	44.5	43.5	42.2	40.7	38.9	36.8	34.5	31.8	28.6	24.2
⑤	APG 1000/2/G50H A0FT5	53.0	51.8	50.7	49.4	48.0	46.3	44.3	42.0	39.2	35.8	31.2

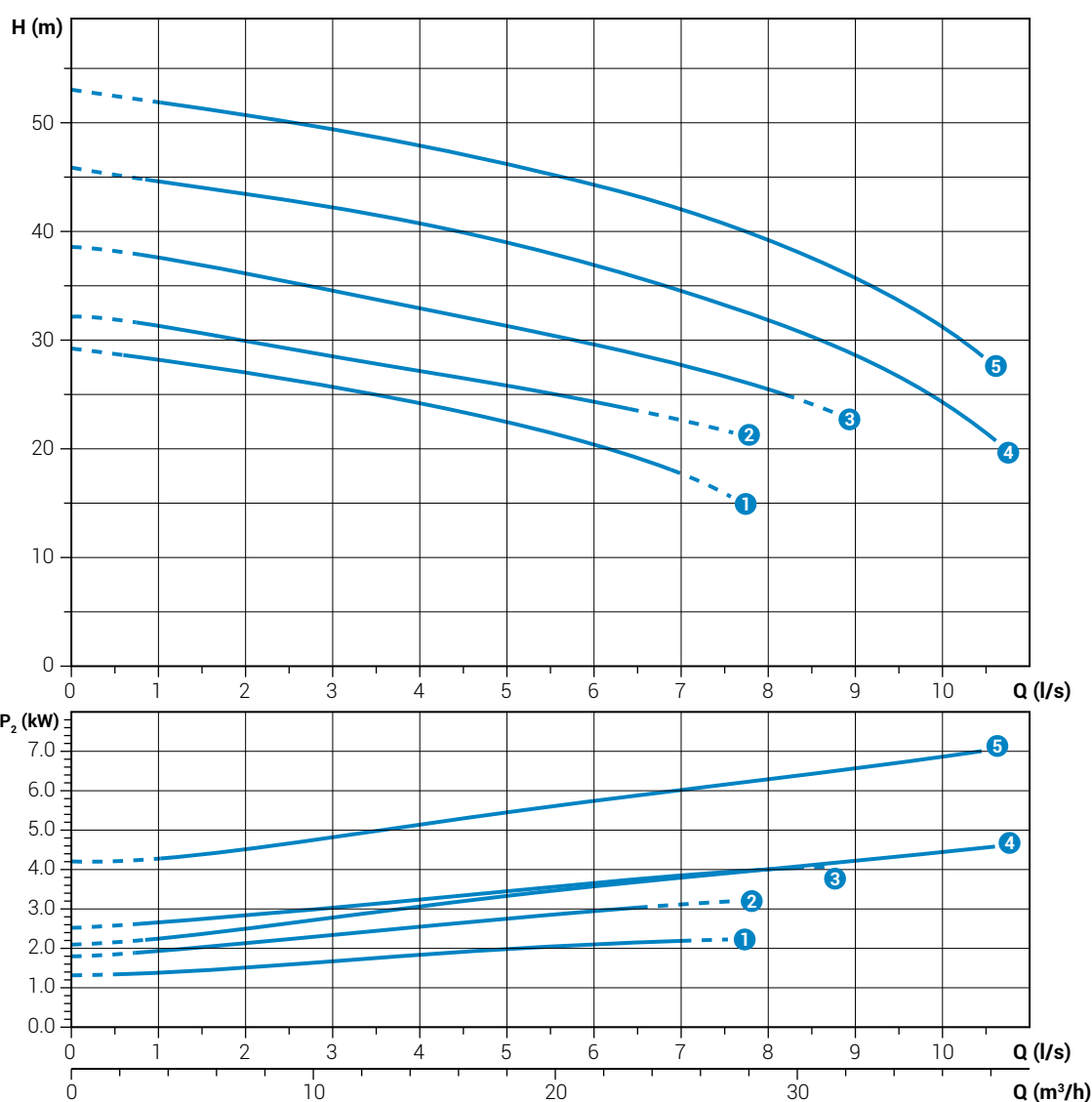

Characteristic curves according to UNI EN ISO 9906

Technical data

	V	Phases	P1 (kw)	P2 (kw)	A	Rpm	Start	Cable	Ø	Free passage	
①	APG 300/2/G50H C0ET5	400	3	2.76	2.2	4.62	2900	Dir	4G1.5+3x1	DN32-G2"	8 mm
②	APG 400/2/G50H D0ET5	400	3	3.68	3.0	6.36	2900	Dir	4G1.5+3x1	DN32-G2"	8 mm
③	APG 550/2/G50H D0FT5	400	3	4.66	4.0	7.73	2900	Dir	4G1.5+3x1	DN32-G2"	8 mm
④	APG 750/2/G50H A0FT5	400	3	6.32	5.5	10.8	2900	Dir	4G1.5+3x1	DN32-G2"	10 mm
⑤	APG 1000/2/G50H A0FT5	400	3	8.51	7.5	13.7	2900	Dir	4G1.5+3x1	DN32-G2"	10 mm

APG

Overall dimensions and weights

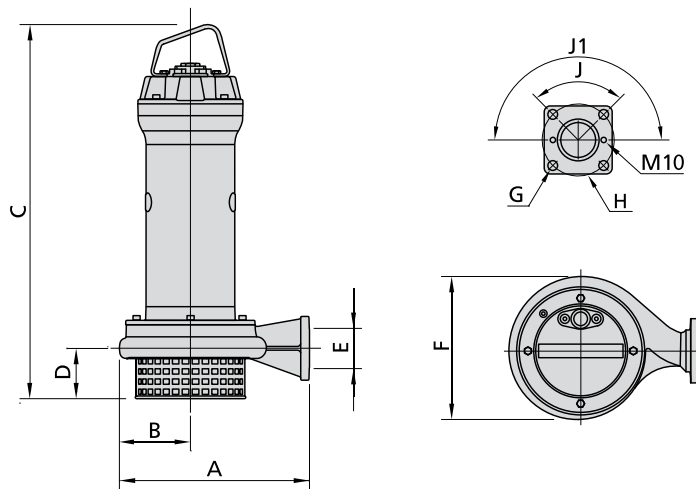

	A	B	C	D	E	F	G	H	J°	J1°	kg
APG 250/2/G40H A0AT5	267	107	523	78	GAS 1½" - DN32	215	14	90	90	-	32
APG 300/2/G50H C0ET5	305	110	550	79	GAS 2" - DN32	225	18	125	45	90	58.6
APG 400/2/G50H D0ET5	352	132	613	76	GAS 2" - DN32	263	18	125	45	90	60.6
APG 550/2/G50H D0FT5	352	132	670	76	GAS 2" - DN32	263	18	125	45	90	57.0
APG 750/2/G50H A0FT5	352	128	669	76	GAS 2" - DN32	263	18	125	45	90	59.7
APG 1000/2/G50H A0FT5	352	128	744	76	GAS 2" - DN32	263	18	125	45	90	68.7

Dimensions in mm

Packaging dimension



	X	Y	Z
APG 250/2/G40H A0AT5	310	580	310
APG 300/2/G50H C0ET5	445	725	425
APG 400/2/G50H D0ET5	445	725	425
APG 550/2/G50H D0FT5	445	725	425
APG 750/2/G50H A0FT5	445	725	425
APG 1000/2/G50H A0FT5	535	915	560

Dimensions in mm



water solutions